



OPERATORS MANUAL FOR Mi-T-M®
***WCP AUTOMATIC
BACKWASH SERIES***
WATER RECYCLING TREATMENT SYSTEM



CAUTION

RISK OF INJURY!

READ MANUAL BEFORE OPERATING!

This manual is an important part of the water recycling treatment system and must remain with the unit when you sell it!

Table of Contents

INTRODUCTION	3
CONTENTS OF WCP-SERIES WATER RECYCLING TREATMENT SYSTEM	4
SPECIFICATIONS	4
IMPORTANT SAFETY WARNINGS	5-7
RISK OF ELECTRIC SHOCK OR ELECTROCUTION	5
RISK OF EXPLOSION OR FIRE	6
RISK OF BURSTING	6
RISK OF BURNS	6
RISK FROM MOVING PARTS	7
RISK OF BODILY INJURY	7
FLOW DIAGRAM	8-9
FEATURES	10-11
INSTALLATION	12-15
PRESTART CHECKLIST	15
PREPARATION	16-25
PRESTART PROCEDURES	16
START-UP	16
pH AND ORP CONTROL SYSTEM	17
INSTALLATION OF pH & ORP PROBES	18
SETTING THE pH AND ORP METER	19-20
SETTING THE TIMERS	21
PROGRAMMING INSTRUCTIONS FOR THE TIME SWITCH.....	22-25
OPERATION	26
MAINTENANCE	27-31
WASTE OIL DECANter	27
SOLIDS COLLECTION AREA	27
BACKWASHING OF FILTERS	28
ACTIVE CARBON TEST	29
REMOVING & REFILLING MEDIA FROM THE MULTIMEDIA & POLISHING FILTER.....	30
SLIDE VALVE.....	30
WATER TESTING	31
WINTERIZING	31
TROUBLESHOOTING	32-38
REPLACEMENT PARTS	38
STATEMENT OF WARRANTY	39

WARNING

This product contains one or more chemicals known to the State of California to cause cancer and birth defects or other reproductive harm.

INTRODUCTION

Congratulations on the purchase of your new Mi-T-M water recycling treatment system! You can be assured your Mi-T-M water recycling treatment system was constructed and designed with quality and performance in mind. Each component has been rigorously tested to ensure the highest level of acceptance.

This operator's manual was compiled for your benefit. By reading and following the simple safety, installation, operation, maintenance and troubleshooting steps described in this manual, you will receive years of trouble free operation from your new Mi-T-M water recycling treatment system. The contents of this manual are based on the latest product information available at the time of publication. Mi-T-M reserves the right to make changes in price, color, materials, equipment, specifications or models at any time without notice.

! IMPORTANT !

These paragraphs are surrounded by a "SAFETY ALERT BOX". This box is used to designate and emphasize Safety Warnings that must be followed when operating this water recycling treatment system.

Accompanying the Safety Warnings are "signal words" which designate the degree or level of hazard seriousness. The "signal words" used in this manual are as follows:

DANGER: Indicates an imminently hazardous situation which, if not avoided, WILL result in death or serious injury.

WARNING: Indicates a potentially hazardous situation which, if not avoided, COULD result in death or serious injury.

CAUTION: Indicates a potentially hazardous situation which, if not avoided MAY result in minor or moderate injury.



The symbols set to the left of this paragraph are "Safety Alert Symbols". These symbols are used to call attention to items or procedures that could be dangerous to you or other persons using this equipment.

ALWAYS PROVIDE A COPY OF THIS MANUAL TO ANYONE USING THIS EQUIPMENT. READ ALL INSTRUCTIONS BEFORE OPERATING THIS WATER RECYCLING TREATMENT SYSTEM AND ESPECIALLY POINT OUT THE "SAFETY WARNINGS" TO PREVENT THE POSSIBILITY OF PERSONAL INJURY TO THE OPERATOR.

Once the unit has been removed from the crate, immediately write in the serial number of your unit in the space provided below.

SERIAL NUMBER _____

Inspect for signs of obvious or concealed freight damage. If damage does exist, file a claim with the transportation company immediately. Be sure that all damaged parts are replaced and that the mechanical and electrical problems are corrected prior to operation of the unit. If you require service, contact Mi-T-M Customer Service at 1-800-553-9053 for the Sales or Service Center nearest you.

Please have the following items available for all Service calls:

1. Model Number
2. Serial Number
3. Date and Place of Purchase

CONTENTS OF WCP-SERIES WATER RECYCLING TREATMENT SYSTEM

Carefully unpack your new Mi-T-M WCP-Series Water recycling treatment system. Check the contents against the packing list. Contact the freight line if a damage claim is required on any component. The following items are the basic equipment sent with your WCP-Series Water recycling treatment system.

- | | |
|--|--|
| <ol style="list-style-type: none"> 1. Water recycling treatment system Platform <ol style="list-style-type: none"> a. Clarifier Type Oil/Solids Separator <ol style="list-style-type: none"> 1. Clarifier Tank 2. Tank Stand b. Ozone Generator c. Ozone Pump d. Filter Pump e. Inlet Flow Meter f. Filter Flow Meter g. Multi-Media Filter h. Polishing Filter i. Transfer Pump j. Pressurized Water Storage Tank k. Waste Oil Decanter | <ol style="list-style-type: none"> 2. Sump Pump 3. Three Unattached Floats for Sump Pit <ol style="list-style-type: none"> a. Blue: Protects sump pump low level. b. Red: To fill pit from the water recycling treatment system. c. Green: High pit level discharge. 4. Sludge Tub w/ Bags 5. Sludge Hose 6. Water Test Kit 7. Manual 8. pH Sensor Probe 9. ORP Sensor Probe |
|--|--|

SPECIFICATIONS

MODEL	WCP-30AB-0M10
MAX FLOW	30 GPM
ELECTRICAL	230 VOLT / 1 PHASE / 37 MAX AMP
SUMP PUMP	3/4 HP
OZONE GENERATOR	MEDIUM FLOW
OZONE PUMP	1/2 HP
CLARIFER CAPACITY	600 GALLONS
OIL COALESCING AREA	425 SQUARE FEET
FILTER PUMP	1-1/2 HP
MULTI-MEDIA FILTER	900 LBS
POLISHING FILTER	440 LBS DEGASSED
TRANSFER PUMP	2 HP
DIMENSIONS	108" X 84" X110"
NET WEIGHT	3225 LBS



IMPORTANT SAFETY WARNINGS

WARNING: When using this product, basic precautions should always be observed, including the following:
READ ALL SAFETY WARNINGS BEFORE USING WATER RECYCLING TREATMENT SYSTEM







HAZARD	POTENTIAL CONSEQUENCE	PREVENTION
<p data-bbox="180 233 537 289">RISK OF ELECTRIC SHOCK OR ELECTROCUTION</p> 	<p data-bbox="558 233 976 449">Serious injury or death could occur if the water recycling treatment system is not properly grounded. Your water recycling treatment system is powered by electricity and may cause electric shock or electrocution if not installed properly.</p> <p data-bbox="558 940 976 1031">Electrical shock may occur if water recycling treatment system is not operated properly.</p> <p data-bbox="558 1192 976 1283">Serious injury or death may occur if electrical repairs are attempted by unqualified persons.</p>	<p data-bbox="1002 233 1531 323">Installation of this unit, including all electrical connections, must comply with all local, state and national codes.</p> <p data-bbox="1002 344 1531 527">This product must be grounded. Connect to a GFCI circuit breaker when available. If the unit should malfunction or breakdown, grounding provides a path of least resistance for electric current to reduce the risk of electric shock. Do not ground to a gas supply line.</p> <p data-bbox="1002 548 1531 701">Improper connection of the equipment-grounding conductor can result in a risk of electrocution. Check with a qualified electrician or service personnel if you are in doubt as to whether the system is properly grounded.</p> <p data-bbox="1002 722 1531 875">Always be certain the unit is receiving proper voltage (+/- 5% of the voltage listed on the nameplate). Before installing electrical connections, be certain the power switches are in the "OFF" position.</p> <p data-bbox="1002 896 1531 924">Keep all connections dry and off the ground.</p> <p data-bbox="1002 945 1531 1035">DO NOT allow metal components of the water recycling treatment system to come in contact with live electrical components.</p> <p data-bbox="1002 1056 1531 1176">Never operate the water recycling treatment system with safety guards/covers removed or damaged. Ensure all electrical covers are securely in place when unit is operating.</p> <p data-bbox="1002 1197 1531 1350">Any electrical wiring or repairs performed on this water recycling treatment system should be done by Authorized Service Personnel in accordance with National and Local electrical codes.</p> <p data-bbox="1002 1371 1531 1715">Before opening any electrical enclosure, always shut off the water recycling treatment system and drain the water. Disconnect the water recycling treatment system from the power source. If the power disconnect is not in sight, lock it in the open position and tag it to prevent power usage. (Never assume the water recycling treatment system is safe to work on just because it is not operating, it could restart at any time! Always disconnect from the power source.)</p>



IMPORTANT SAFETY WARNINGS

READ ALL SAFETY WARNINGS BEFORE USING WATER RECYCLING TREATMENT SYSTEM

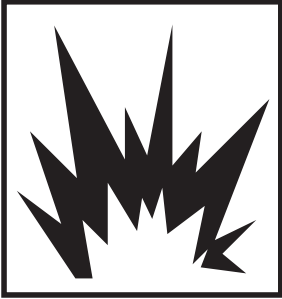

HAZARD	POTENTIAL CONSEQUENCE	PREVENTION
<p>RISK OF EXPLOSION OR FIRE</p>  	<p>Serious injury or death could occur from an explosion or fire caused by a system electric spark.</p>	<p>This unit must be placed in an area that is well ventilated, free of flammable vapors, combustible dust, gases or other combustible materials.</p>
<p>RISK OF BURSTING</p> 	<p>Serious injury or death could occur from bursting caused by excessive pressure in the system.</p> <p>Serious injury may occur if attempting to start the water recycling treatment system when the pump is frozen.</p>	<p>Do not mistreat the pressure gauges on the system. Pressure gauges will malfunction if they are subjected to excessive pressure, vibration, pulsation or temperature or if they are placed in an environment which causes corrosion of parts. Incorrect readings on a pressure gauge could mislead the operator and place him in a dangerous working condition.</p> <p>Do not use a booster pump or any type of additional pumping system. Pressurizing the suction of the pump may cause the pump body to explode.</p> <p>Do not use this water recycling treatment system to pump flammable material! An explosion could occur from a gas vapor buildup inside the system.</p> <p>In freezing temperatures, the unit must always be warm enough to ensure there is no ice formation in the pump. Do not start the water recycling treatment system if it has been in a freezing environment without first allowing the pump to thaw.</p>
<p>RISK OF BURNS</p> 	<p>Serious injury may occur from touching the electrical motor. This area can remain hot for some time after the water recycling treatment system is shutdown.</p>	<p>Never allow any part of your body to contact the electrical motor until cooled.</p>

FLOW DIAGRAM

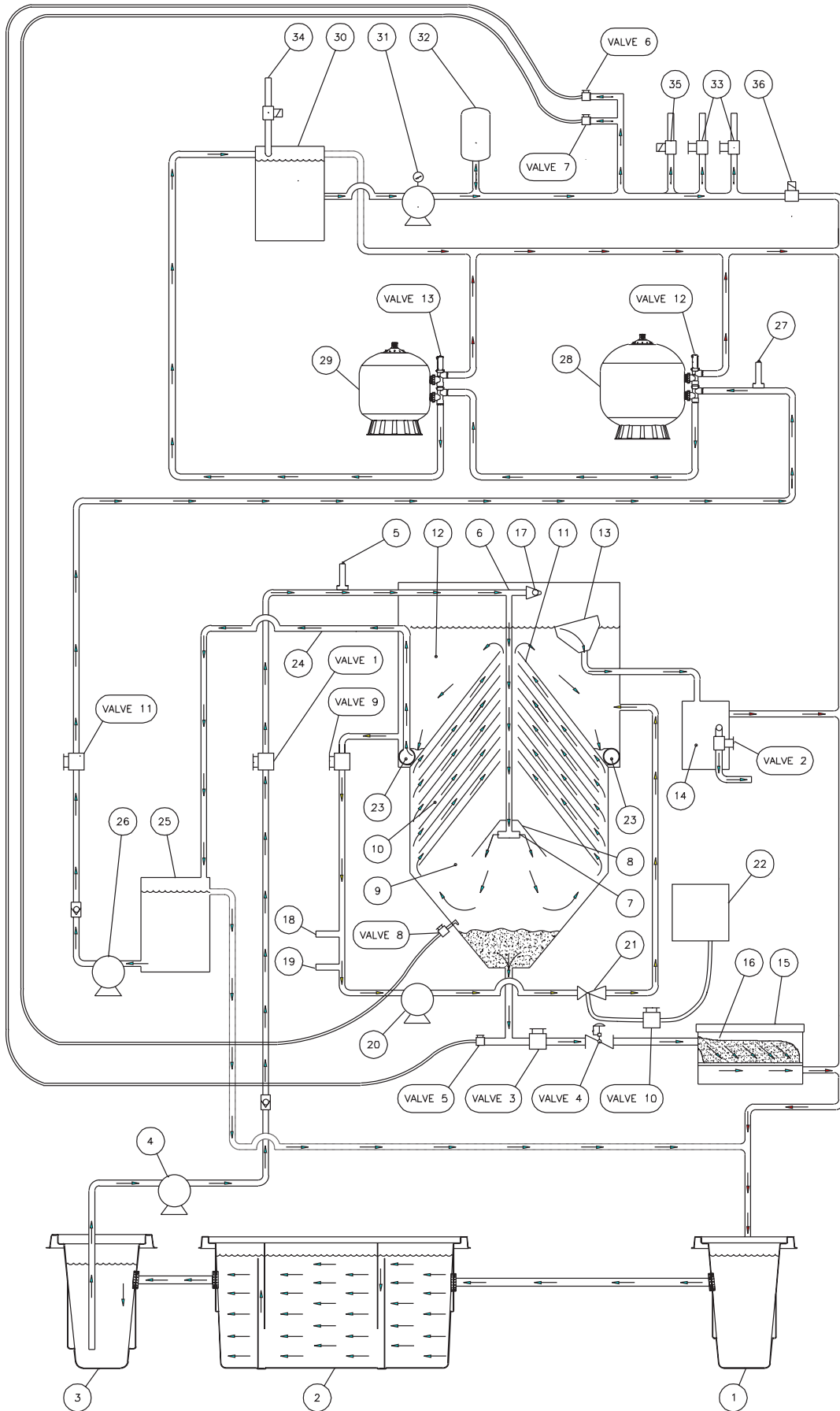

FLOW DIAGRAM WCP-30AB-011302-KS

FLOW DIAGRAM

As pressure washers are being operated, used water flows into the **Wash Water Catch Pit (1)**. From there, it moves to the **3-Stage Collection Pit (2)**. Heavy debris falls to the bottom of the pit where it is trapped by a weir which is designed to stop heavy debris while allowing the remaining water to move into the **Sump Pit (3)**. The **Sump Pump (4)** draws water from the **Sump Pit (3)** and brings it through the *Water Inlet Flow Control Valve 1*. This adjustable valve is used to regulate the flow of water entering the water clarification tank. A **Flow Meter (5)** is positioned just ahead of the water clarification tank. The water enters the water clarification tank through the **Inlet Tee (6)** and is directed down to the **Diverter Tee (7)**. From there the water is deflected downward by the **Solids Deflection Cone (8)**, then to the **Solids Separation Chamber (9)**. The **Solids Separation Chamber (9)** allows the velocity of the water to slow so that any suspended solids settle to the bottom. The water then rises up through the **Oil Coalescing Cones (10)**.

- 1) The non-emulsified oil molecules in the water adhere to the **Oil Coalescing Cones (10)**. When enough oil molecules attach to each other, they form oil droplets. The oil droplets are carried along with the water through the **Top Separator Cone (11)** and into the **Oil Separation Chamber (12)**, where the oil droplets float to the surface. The **Oil Skimmer (13)** is positioned near the top of the **Oil Separation Chamber (12)** which allows the thin layer of surface oil and water to drain into the **Waste Oil Decanter (14)**. Since oil is lighter than water, the oil floats to the top and is released from the **Waste Oil Decanter (14)** when the *Waste Oil Release Valve 2* is opened. Excess water is returned to the **Wash Water Catch Pit (1)**.
- 2) The solids that accumulate in the bottom of the **Solids Separation Chamber (9)** will be drained weekly (factory set) through the *Automatic Solids Drain Valve 3* into the **Sludge Tub (15)** where the solids are filtered out and the water is returned to the **Wash Water Catch Pit (1)**. The **Filter Bag (16)** is biodegradable and may be tied off and disposed of as it is filled. Note that the *Manual Solids Drain Valve 4* should remain in the open position during normal operation. If the solids accumulated at the bottom of the **Solids Separation Chamber (9)** are unable to drain, open *Valve 5* and *Valve 6* to push the solids towards the **Sludge Tub (15)**. If the solids are still unable to drain, open *Valve 7* and *Valve 8* to break up the solids on the inside of the **Solids Separation Chamber (9)**. When the solids from the **Solids Separation Chamber (9)** is emptied, close *Valve 5*, *Valve 6*, *Valve 7* and *Valve 8*.
- 3) An **Anti-siphon Device (17)** is attached to the **Inlet Tee (5)** to relieve any suction that may develop when the **Sump Pump (4)** is turned off, preventing any siphoning of water back out of the water clarification tank.

Water then flows through the *Ozone Pump Valve 9* down past the **Sensor Probes (18 & 19)** then into the **Ozone Pump (20)** where it is forced through the **Ozone Injector (21)** and back up into the **Oil Separation Chamber (12)**. (See "pH & ORP Control System" for details.)

- 1) Ozone is generated by oxygen molecules passing through a corona discharge **Ozone Generator (22)**. This is an electric charge which causes the oxygen atoms to become ozone molecules. Since ozone molecules are extremely unstable, they only retain their structure for a very short time. For this reason, ozone cannot be stored, but must be continually produced by the **Ozone Generator (22)**.
- 2) Ozone kills bacteria approximately 3,000 times faster than chlorine.
- 3) The flow of ozone is controlled by the *Ozone Flow Control Valve 10*.

Water then flows from the **Oil Separation Chamber (12)** through the **Outlet Ring (23)** and into the **Outlet Y (24)**. The **Outlet Y (24)** directs the water into the **Product Tank (25)** where the **Filter Pump (26)** sends the water to the *Filter Control Valve 11* which regulates the amount of water going into the filtering system. (Flow is factory set at 30 gallons per minute.) A **Flow Meter (27)** is positioned just ahead of the **Multi-Media Filter (28)** to monitor flow. The *Multi-Media Filter Valve 12* has two positions: Filter and Backwash. When in the "Filter" Position, water flows into the **Multi-Media Filter (28)** from the top and passes through several layers of filtering product as it moves toward the bottom. By the time the water reaches the bottom to the filter tank, the contaminants have been filtered down to approximately 20 microns. Laterals are positioned at the bottom of the filter tank, which absorb the filtered water and move it up through the center and out the side of the tank. From there, the water flows into the *Polishing Filter Valve 13*. This valve has two positions: Filter and Backwash. When in the "Filter" position, water flows into the **Polishing Filter (29)** from the top and passes through the activated carbon or filtering agent. As it moves toward the bottom, the activated carbon or filtering agent absorbs odor and contaminants while "polishing" the water. Laterals are positioned at the bottom of the tank, which absorb the water and move it up through the center and out the side of the tank. From there, the water moves to the **Product Tank (30)** where the recycled water is held until usage is required. When needed, water is pulled from the **Product Tank (25)** by the **Transfer Pump (31)** and moved into the **Pressure Tank (32)**. This tank holds water at 30-50 PSI/2.0-3.5 Bar. Water moves directly from this tank to the water discharge outlets upon demand. If water is needed for washing, water is sent to the **Outlet To Pressure Washer (33)**. If the **Wash Water Catch Pit (1)** water level is low, water is added through the **Fresh Water Makeup (34)**. If the **Wash Water Catch Pit (1)** water level is too high, water is sent to the **Rain Water Overflow (35)**. If the recycle timer turns on, water is sent through the **Recycled Wash Water (36)** to the **Wash Water Catch Pit (1)**.

FEATURES FOR WCP-30AB

FEATURES FRONT ISO & CONTROL PANEL-WCP-30AB-122904-UPDATE

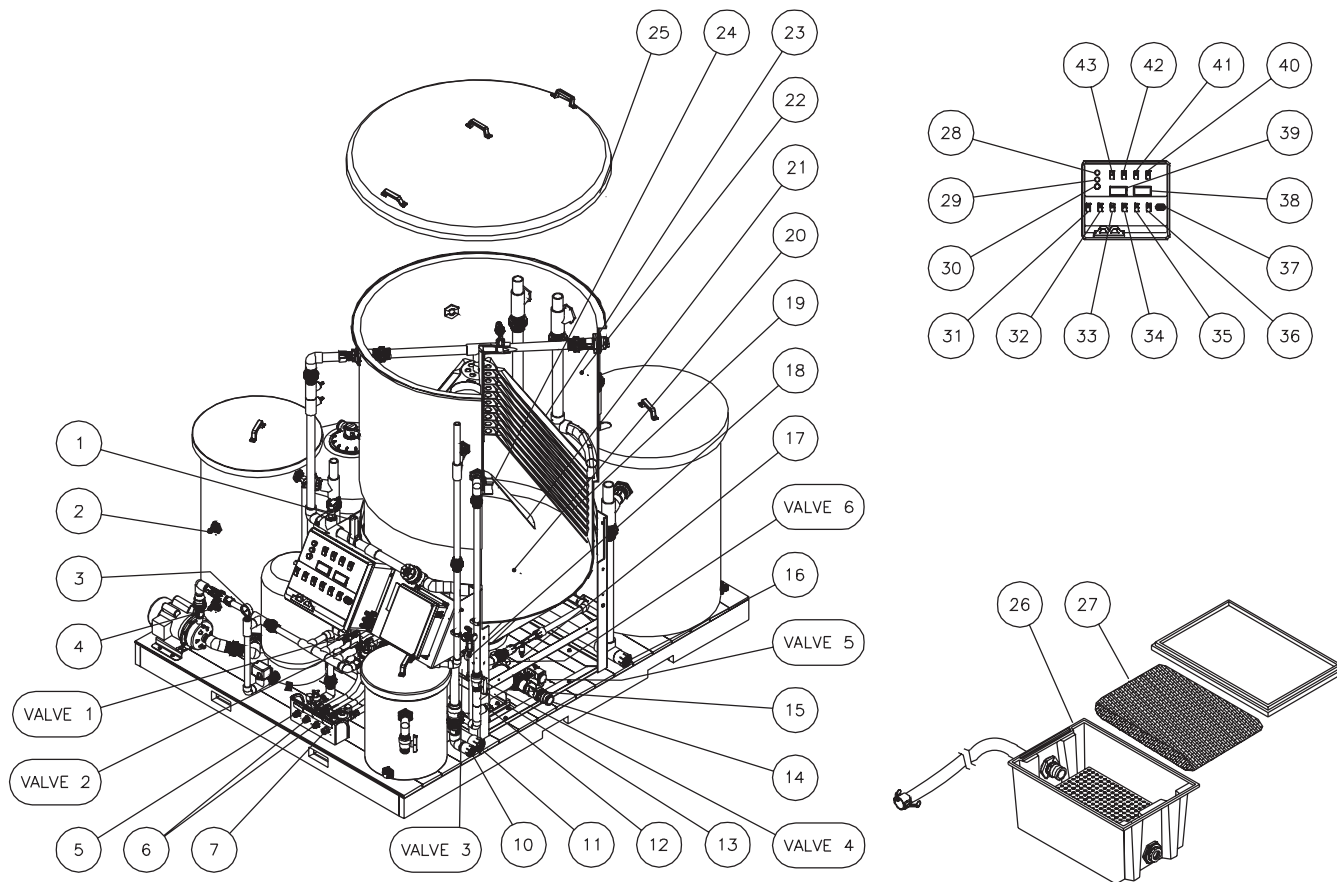

VALVE DESCRIPTIONS

UNIT DESCRIPTIONS

1. Pressurized Clean-Out (Sludge Outlet)
2. Pressurized Clean-Out (Solids Chamber)
3. Ozone Flow Control
4. Ozone Pump
5. Automatic Solids Drain
6. Manual Solids Drain
7. Filter Pump Flow Control
8. Multi-Media Slide Valve
9. Polish Filter Slide Valve
10. Oil Decanter Shut Off Valve
11. Main Inlet Flow Control
12. Auto Backwash Flow Control

1. Inlet Flowmeter
2. High Filter Pump Float
3. Pressure Gauge: Transfer Pump
4. Transfer Pump Float
5. Rain Water Overflow
6. Outlet to Pressure Washer
7. Fresh Water Makeup
10. Inlet From Sump Pump
11. Outlet Return To Pit
12. ORP Sensor Probe
13. pH Sensor Probe
14. Sludge Outlet
15. Ozone Pump

16. Outlet Return To Pit
17. Ozone Injector
18. Air System Inlet
19. Oil Coalescing Cones
20. Solids Separation Chamber
21. Solids Deflection Cone
22. Oil Separation Chamber
23. Top Separator Cone
24. Diverter Tee
25. Lid
26. Sludge Tub
27. Filter Bag
28. Power Indicator Light
29. Indicator Light: Backwashing
30. Start Backwash Switch

FEATURES FOR WCP-30AB

FEATURES REAR ISO & TOP DOWN WCP-30AB-091202-KS

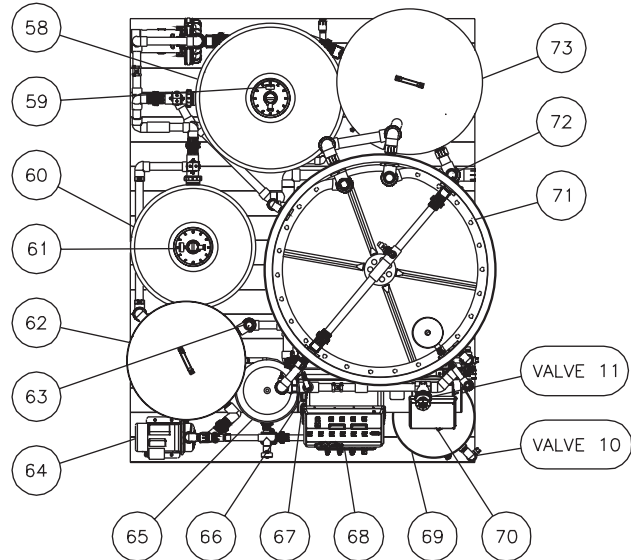
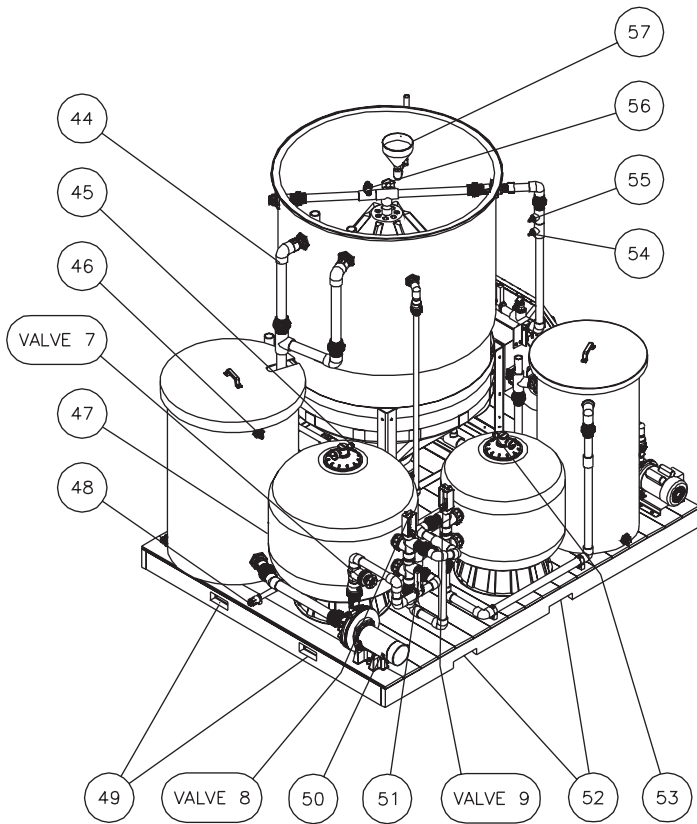

UNIT DESCRIPTIONS

- | | | |
|--|---|--------------------------------------|
| 31. Sump Pump Switch (ON/OFF) | 46. High Sump Pump Float | 61. Pressure Gauge: Polishing Filter |
| 32. Filter Pump Switch (ON/OFF) | 47. Low Filter Pump Float (Not Visible) | 62. Product Tank |
| 33. Transfer Pump Switch (ON/OFF) | 48. Remote Multi-Media Filter Drain | 63. Product Tank Overflow |
| 34. pH/ORP Meters Switch (ON/OFF) | 49. End Fork Lift Holes | 64. Transfer Pump |
| 35. pH Pump Switch (ON/OFF) | 50. Filter Pump | 65. Pressure Tank |
| 36. ORP Pump Switch (ON/OFF) | 51. Filter Flowmeter | 66. pH Pump |
| 37. Hour Meter | 52. Side Fork Lift Holes | 67. ORP Pump |
| 38. ORP Meter | 53. Air Relief Valve | 68. Control Panel |
| 39. pH Meter | 54. ORP Chemical Injector | 69. Waste Oil Decanter |
| 40. Ozone Generator | 55. pH Chemical Injector | 70. Ozone Generator |
| 41. Ozone Pump | 56. Anti-Siphon Device | 71. Outlet Ring |
| 42. Auto-Backwash Controller (Auto/Manual) | 57. Oil Skimmer | 72. Holding Tank Overflow |
| 43. Clarifier Drain Valve (Open/Close) | 58. Multi-Media Filter | 73. Holding Tank |
| 44. Outlet Y | 59. Pressure Gauge: Multi-Media Filter | |
| 45. Air Relief Valve | 60. Polishing Filter | |

INSTALLATION

NOTE: *Proper Attire is essential to your safety. It is advised to utilize whatever means necessary to protect eyes, ears, and skin.*

1. A Collection Pit System must already be an established structure before installing the WCP-Series water recycling treatment system. A well designed pit system is critical for the proper operation of the recycle system. Consult your Mi-T-M dealer for installation requirements.
2. Place the water recycling treatment system platform on a hard, level surface in an area free of flammable vapors, combustible dust, gases or other combustible materials.
3. Set the unit so you have access to all four sides.
4. Do not place unit in an area:
 - a. with insufficient ventilation.
 - b. where environmental hazards (i.e. rain and snow) can come in contact with the water recycling treatment system.
 - c. where the unit may freeze.
5. The water recycling treatment system is shipped with some union connections loosened to protect the unit from shipping damage. Tighten all union connections at this time.

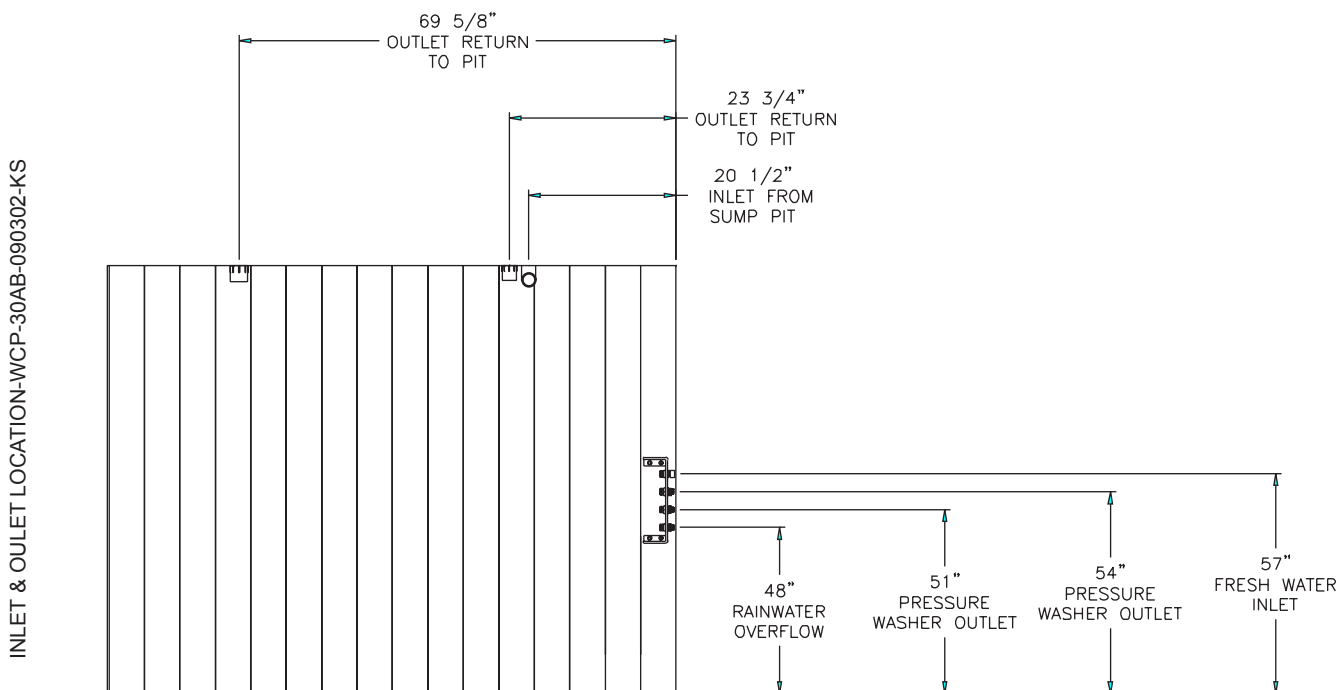

INSTALLATION

6. Use schedule 80 PVC slip connections.
 - a. Install the **Sump Pump** in the plumbing in between the **Sump Pit** and the unit. Install the **Sump Pump** close to the **Sump Pit** to reduce priming time.
 - b. Install plumbing from the Sump Pit to the **Sump Pump** using minimum connection sizes of 2".
 - c. Install a check valve in the **Sump Pit**.
 - d. Install plumbing from the **Sump Pump** to the unit using 1-1/2" minimum plumbing.
 - e. Install plumbing from **BOTH Outlet Return To Pit** lines to the **Wash Water Catch Pit** using a minimum pipe size of 3".
 - f. Install plumbing from the **Sludge Tub** to the **Wash Water Catch Pit**. Position the **Sludge Tub** so that the **Sludge Hose** can be connected from the **Sludge Outlet** to the **Sludge Tub**.
7. Install the three floats in the **Sump Pit**. Allow a 2" tether and enough room for them to move freely without interfering with the plumbing.
 - a. Float #1 Blue: Pit low level shut-off. Attach this float 10" above the inlet.
 - b. Float #5 Red: Fresh water makeup. Height of this float must be adjusted to the individual pit system.
 - c. Float #6 Green: Rain water overflow. Height of this float must be adjusted to the individual pit system.

NOTE: The above information is for reference only. Professional installers or architects may use this guideline to meet specific site requirements.

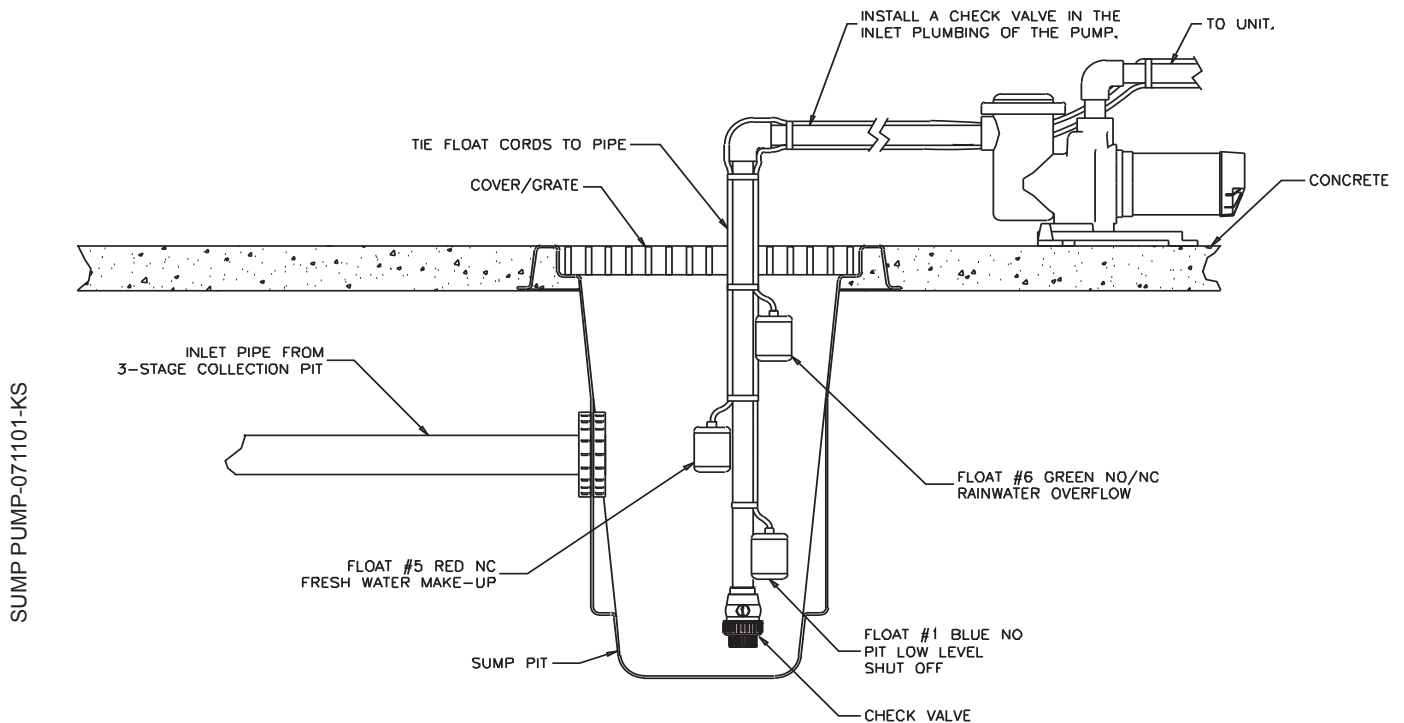

INSTALLATION

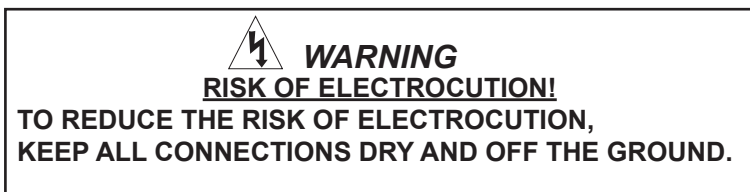

8. A qualified electrician must hook up the electrical system.
 - a. Verify the electrical supply at the power source is off.
 - b. Be certain all switches on the **Control Panel** are in the "OFF" position.
 - c. Run water tight conduit or cord from the **Sump Pump** and Floats to the **Control Panel**.
 - d. Run water tight conduit from the local disconnect to the **Control Panel**.
 - e. The electrician will need to drill holes in the **Control Panel** for the conduit and/or cord(s).
 - f. Make connections to the terminal strips as shown below.

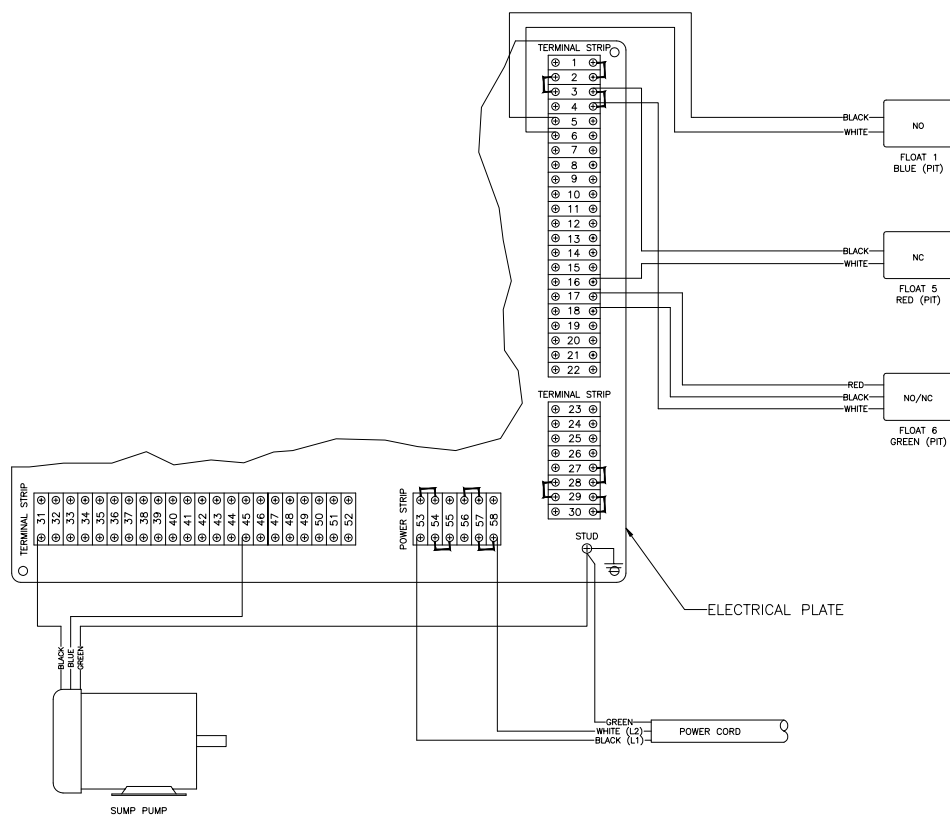

FIELD WIRING DIAGRAM WCP-30AB-122904-ASY

9. Make the following hose connections:
 - a. From a pressurized water supply to the **Fresh Water Makeup**.
 - b. From the **Outlet to Pressure Washer** to the pressure washer.
 - c. From the **Rain Water Overflow** to a storage tank for further processing or disposal. **DO NOT SEND THIS WATER BACK TO THE WASH WATER CATCH PIT!**
 - d. Connect the **Sludge Hose** to the **Sludge Outlet** and the **Sludge Tub**.
 - e. From a pressurized air supply to the **Air System Inlet**, turn regulator until gauge reads 60PSI.

NOTE: In most cases, you must have a permit to legally dispose discharged water.

STOP

TO ENSURE YOUR WATER RECYCLE TREATMENT SYSTEM OPERATES SAFELY AND EFFICIENTLY, COMPLETE THE PRE-OPERATION CHECKLIST BEFORE PROCEEDING.

PRE-OPERATION CHECKLIST

Before proceeding, answer all the questions on this checklist.	YES	NO
CODES: 1. Does the electrical wiring meet all codes? 2. Does plumbing meet all codes?		
LOCATION: 1. Is the unit located on a hard level surface free of flammable vapors, combustible dust, gases or other combustible materials? 2. Is the unit located in a large ventilated area?		
ELECTRICAL: 1. Is the unit properly grounded? 2. Does the power supply, voltage and amperage match the data plate?		
PLUMBING: 1. Is the plumbing sized correctly? 2. Is the check valve installed before the Sump Pump ? 3. Are all plumbing connections secured? 4. Are all hose connections secured?		
GENERAL: 1. Have all operators using this unit read and understood this entire manual? 2. Has the unit been installed by qualified service people who followed the instructions listed in this manual?		

NOTE: IF "NO" WAS MARKED TO ANY OF THESE QUESTIONS, CORRECT THE SITUATION BEFORE OPERATING.

PREPARATION

PRESTART PROCEDURES:

1. Position the valves on the WCP water recycling treatment system in the "Start-up Mode".
 - Water Inlet Flow Control Valve: Turn valve one rotation short of completely closed.
 - Filter Control Valve: Turn valve one rotation short of completely closed.
 - Air Bleed Valves: Turn valves open.
 - Oil Release Valve: Turn valve completely closed.
 - Ozone Pump Valve: Turn valve open.
 - Pressurized Clean-Out Valves: Turn valves completely closed.
2. Be certain all hoses are securely connected.
3. Be certain the incoming air tube to the **Ozone Generator** is not obstructed.
4. Be certain all switches on the **Control Panel** and **Ozone Generator** are in the "OFF" position.
5. Turn on the power supply. The **Power Indicator Light** should glow.

START-UP:

1. Ensure water supply to the **Fresh Water Makeup** is turned on and pit is filled with water. If the pit is not full, water will fill the **Product Tank** and overflow through the **Product Tank Overflow** and back to the **Sump Pit**.
2. To prime the **Sump Pump**, remove the lid over the **Basket Strainer** and fill the **Basket Strainer** and the plumbing from **Sump Pit** to the **Sump Pump** with water, then replace the lid.
3. Turn on the **Sump Pump Switch**; water will flow into the **Clarifier Tank**.
4. Flow can be increased by opening the Water Inlet Flow Control Valve and reading the **Inlet Flowmeter**. Fill the **Clarifier Tank**.
5. After the water fills the **Solids Separation Chamber**, it will begin to flow through the **Top Separator Cone** and fill the **Oil Separation Chamber**.
6. As water fills the **Oil Separation Chamber**, the **Ozone Pump** will prime.
7. When the **Oil Separation Chamber** is full, the water will begin to flow through the **Outlet Ring** and into the **Outlet Y**.
8. The **Outlet Y** directs the water into the **Holding Tank** where it is ready to be processed.
9. As the water fills the **Holding Tank**, it will begin to flow out the **Overflow Drain** at the top of the tank. At this point, flow can be adjusted with the Water Inlet Flow Control Valve. Set the flow rate to 30GPM. If the float rises and turns off the **Sump Pump**, reduce the flow rate with the Water Inlet Flow Control Valve.
10. Ensure that the Ozone Pump Valve is open and turn on the **Ozone System Switch** located on the main control panel. The ozone system is working properly when air bubbles are seen in the **Oil Separation Chamber**. If no air bubbles are observed, turn off the **Ozone System Switch** and loosen the union after the **Ozone Pump** until the pump is primed. (The Ozone Flow Control Valve is set at the factory and should not need adjusting.) The **Ozone Generator Switch** can now be turned on.
11. Turn on the **Filter Pump Switch**. The **Filter Pump** will automatically turn off when the **Product Tank** is full of water.
12. As water flows to the filters, use the Filter Control Valve to adjust the water flow to the 30GPM. Check the **Filter Flowmeter** located ahead of the **Multi-Media Filter**.
13. Water will begin to flow from the **Multi-Media Filter** to the **Polishing Filter**. As water flows through the **Multi-Media Filter**, air will automatically bleed from the **Multi-Media Filter** to the **Polishing Filter**.
14. As water flows through the **Polishing Filter**, air will also automatically bleed from the **Polishing Filter** to the **Product Tank**. Air can also bleed from both filters by opening the Air Bleed Valve on each filter.

***NOTE:** DO NOT attempt to backwash the filters until all of the air is bled from the system.*
15. When the **Product Tank** is full and the **Filter Pump** turns off, prime the **Transfer Pump** by opening the **Outlet to Pressure Washer** valve until water exits.
16. Turn on the **Transfer Pump Switch** to allow water to flow into the **Pressure Tank**. The **Transfer Pump** will run until the pressure system reaches 50PSI. This can take up to 7 minutes.
17. Water is now completely cycled in the system.

PREPARATION

pH AND ORP CONTROL SYSTEM:

Proper pH and ORP levels must be maintained in the pit to prevent growth of bacteria, algae, odors, etc. Water must be chemically balanced to effectively recycle. The effectiveness of Safe O³ in the water depends on the pH level.

-The optimum pH level to add Safe O³ is 6.5 - 6.8.

-As the pH level rises to 7.5, about 5% more Safe O³ must be added to achieve the same ORP reading.

-At a pH level of 8.0 and above, a large amount of Safe O³ must be added to increase the ORP reading.

As excess water flows through the **Ozone System**, it moves past the **pH and ORP Sensor Probes** before returning to the **Oil Separation Chamber**. The **Sensor Probes** analyze the pH and ORP levels in the water.

- a. **pH Sensor Probe.** This probe analyzes the pH (acidity & alkalinity) in the water. If the water is too acidic (low pH) the acid will breakdown the iron present in the water to a liquid form, thus causing rusty looking water in the system. If the water is too alkaline (high pH) the bacteria killing potential of the ORP agent will be drastically lowered.

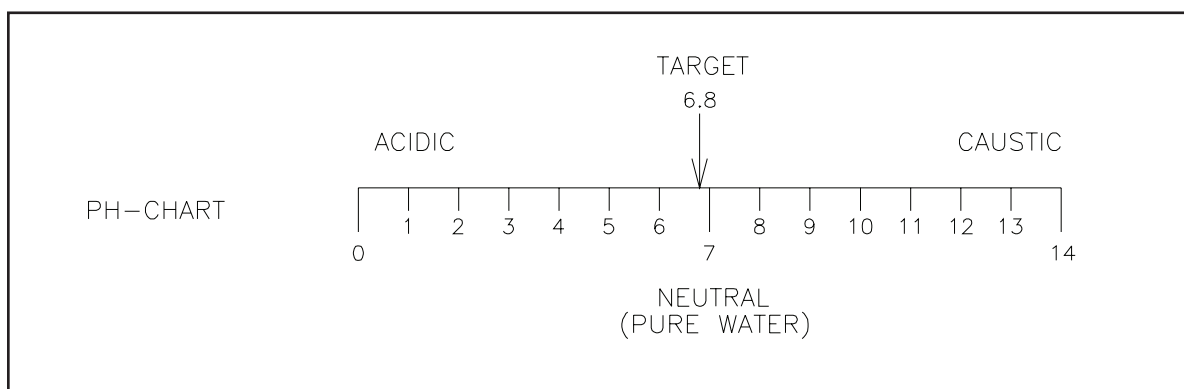

WLP-0008-112098-JJ

- b. **ORP Sensor Probe.** This probe analyzes the Oxidation Reduction Potential (ORP). This reading states amount of bacteria killing agent in the water.

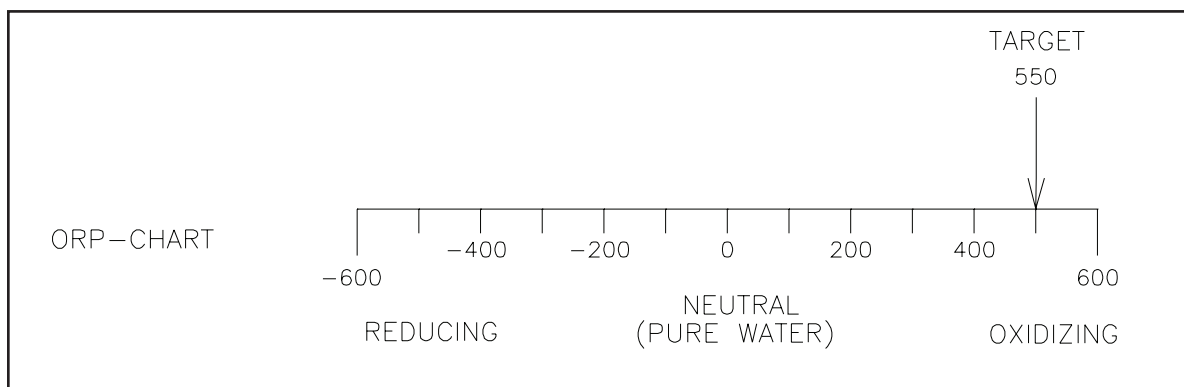

WLP-0009-112098-JJ

The probes analyze the pH and ORP levels of the water and display the readings on the digital **pH and ORP Meters**.

PREPARATION

INSTALLATION OF pH AND ORP PROBES:



CAUTION **RISK OF PROBE DAMAGE!**

- DO NOT ALLOW PROBES TO BE EXPOSED TO AIR. ONCE PROBES ARE IN PLACE, TURN WATER ON IMMEDIATELY.
- HANDLE PROBES CAREFULLY AS THEY ARE MADE OF GLASS.
- DO NOT ALLOW PROBES TO BE EXPOSED TO FREEZING ENVIRONMENTS. KEEP THE ORIGINAL CONTAINERS IN WHICH THE PROBES WERE SHIPPED. THEY WILL BE NEEDED FOR PROBE STORAGE DURING WINTERIZING.

pH SENSOR PROBE

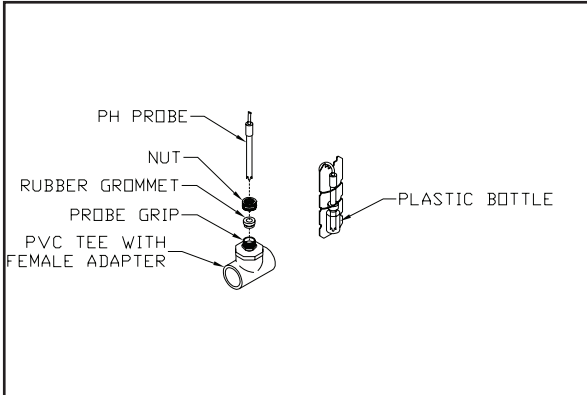

WLP-0006-110298-JJ

ORP SENSOR PROBE

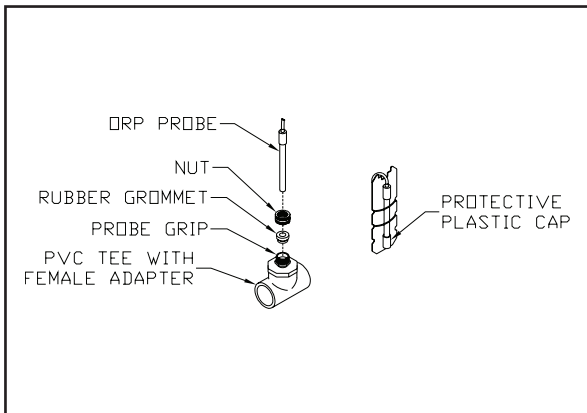

WLP-0007-112098-JJ

1. Turn off the **Ozone System Switch** and close the Ozone Pump Valve.
2. Locate the probe grips in the **Ozone System** plumbing and unscrew the nut from one of the grips.
3. Remove one of the probes (pH or ORP) from its storage container. (Be certain to save the container for probe storage during winterizing.)
4. Carefully slide the probe grip nut over the glass probe.
5. Gently push the probe through the probe grip approximately 2 inches and tighten the nut onto the probe grip.
6. Repeat process for the remaining probe.
7. Immediately open the Ozone Pump Valve to refill the plumbing with water.

THE PROBES CANNOT BE ALLOWED TO DRY OUT.

8. Turn on the **Ozone System Switch**.
9. Turn on the **pH/ORP Meters Switch**.

PREPARATION

SETTING THE pH AND ORP METER:

OPERATION:

Keypad Operation

1. "SEL" key; changes upper display to the first programming menu, advances the display through the menu and sets the programmed information into memory.
2. "∧" up arrow key, increases value displayed in the green (lower) display.
3. "∨" down arrow key, decreases value displayed in the green (lower) display.
4. Press and hold "SEL" key for approximately 3 seconds and "HYS" will appear in the upper display. Hold the "SEL" key for approximately 6 seconds and P-n1 will appear.

Programming

1. How to change the set point

Press and hold the "∧" up or "∨" down arrow until the correct number appears, the new set point will be active after 5 seconds.

2. How to change the control action (Relay activates above or below the set point)

Hold the "SEL" key for approximately 6 seconds and "P-n1" will appear in the upper display, the control code will appear in the lower display, "0" or "1" will actuate below the set point, "2" or "3" will actuate above the set point. Press the "SEL" switch once, the value will flash, change the value with the "up" or "down" keys, and press the "SEL" key again to set it in memory. Holding the "SEL" key for approximately 2 seconds will return to normal operation.

3. How to program Hysteresis

Hold the "SEL" key for approximately 3 seconds and "HYS" will appear in the upper display, the hysteresis amount will appear in the lower display, press the "SEL" key once and the amount will flash, change the amount to the desired value with the "up" or "down" keys, press "SEL" again to set it in memory. Holding the "SEL" key for approximately 2 seconds will return to normal operation.

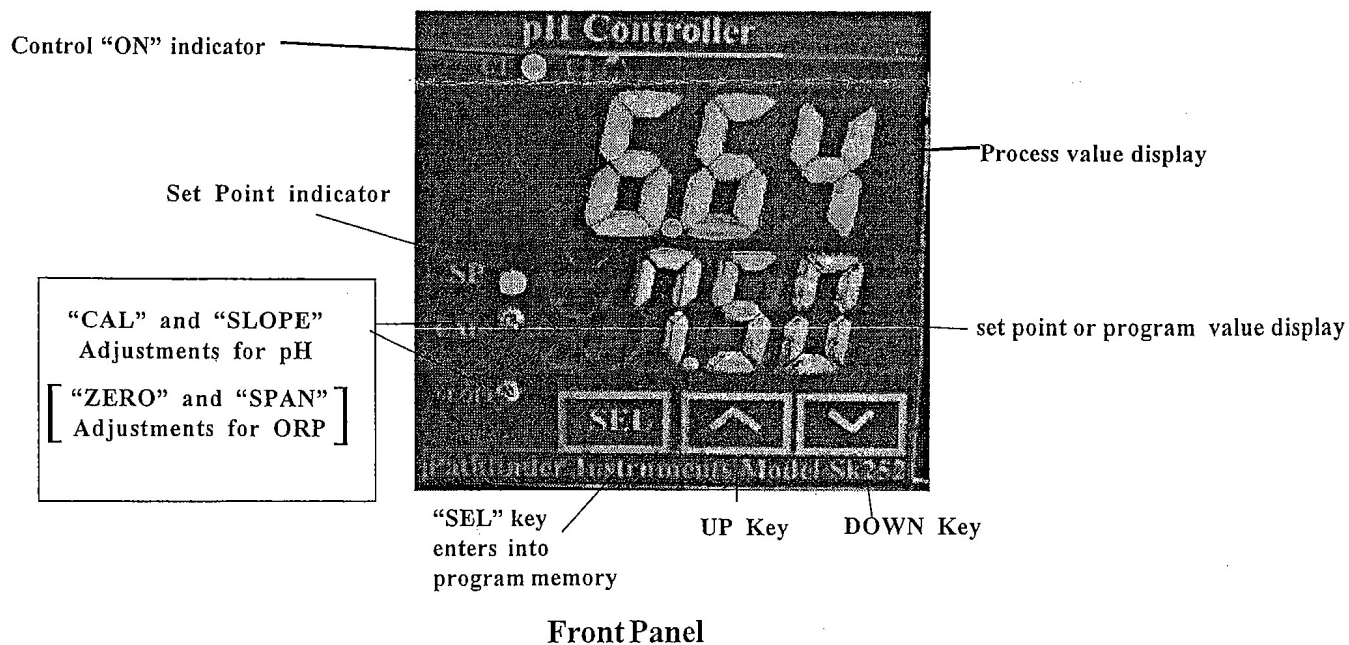

PREPARATION

SETTING THE pH AND ORP METER:

CALIBRATION:

How to calibrate pH:

The front panel has two adjustments labeled "CAL" and "SLOPE", always adjust the CAL first. Place the pH electrode in a #7.00 buffer solution, wait for the reading to stabilize and adjust the SLOPE for a reading of 4.00. Calibration complete.

How to calibrate the ORP:

The front panel has two adjustments labeled "ZERO" and "SPAN", the ORP controller can be calibrated with a millivolt source substituted for a probe.

Short the input connector and adjust the ZERO adjustment for a reading of 0000. Apply +500 mV from an accurate millivolt source and adjust the SPAN adjustment for a reading of 0500.

To verify the accuracy of the ORP probe and ORP calibration, a kit is available from the manufacturer, it consists of enough materials to do 30 tests, it contains reagents, stirrers beakers and instructions.

FINAL pH AND ORP SYSTEM SETUP:

1. Place the hoses from the **pH and ORP Pumps** into the **Adjustment Chemicals**.
 - a. The recommended pH chemical for this system is aluminum sulfate.
 - b. The recommended ORP chemical for this system is Safe O³.
2. Turn on the **pH and ORP Pump Switches**. Chemicals will be inserted into the water as necessary.

PREPARATION

SETTING THE TIMERS:

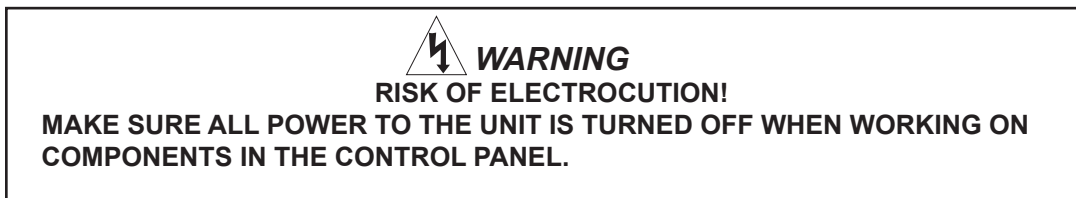

Two timers are located in the main area of the unit control panel. The first is an electronic timer used to operate the clarifier drain valve. Second is a time switch used to operate the water recycling system and the auto-backwash system. These timers have been pre-set at the factory.

ELECTRONIC TIMER:

A simple Phillips head screwdriver can be used to make the adjustment here. Available settings on both range setting adjustments are:

1 second, 3 seconds, 10 seconds, 1 minute, 3 minutes, 10 minutes, 1 hour, 3 hours, 10 hours, and 60 hours.

The time dials determine the percent value of the range settings from 0 to 1.0. As an example, if the range setting is at 10 hours, and the corresponding time dial is at 0.8, then the value for that function is 80% of 10 hours, or 8 hours.

Range setting/ timer dial setting one determines the frequency of the timer activation. It is set to activate every 8 hours. Range setting/ timer dial setting two determines the duration of the timer activation. Duration of the dump cycle is set for 8 seconds. The slide switch should remain in the up position.

TIME SWITCH:

The time switch is used as a dual functioning timer. The first function (C1) is set to activate the auto-backwash system once a day at 9 PM. Secondly, the time switch is used to activate the water recycling system (C2) once a day at 2 AM. If the water in the recycle system lies dormant for more than six hours, it tends to become stagnant and odorous. Dependant on use, you may need to add one or two more daily cycles to this timer program

When setting the time switch, a program must be entered for both the turn on time and the turn off time. Each on cycle and off cycle count as one program. There are 42 programs available on this time switch. FOR COMPLETE PROGRAMMING INSTRUCTIONS FOR THE TIME SWITCH, PLEASE REFER TO THE MANUFACTURERS MANUAL on the following pages.

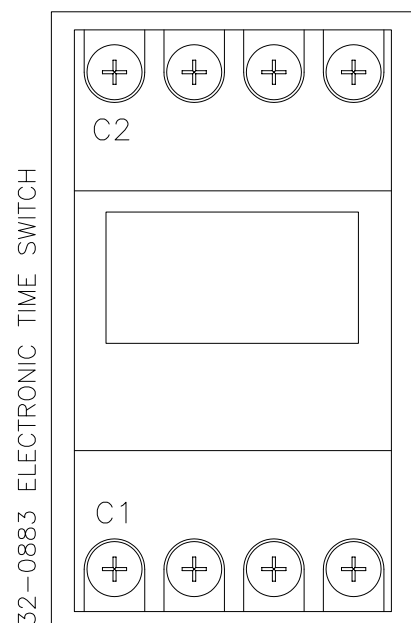
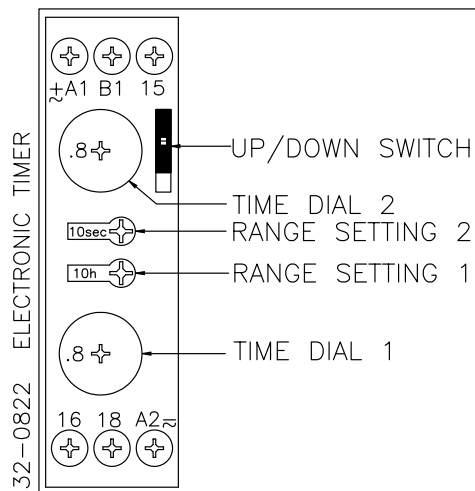

PREPARATION

PROGRAMMING INSTRUCTIONS FOR THE TIME SWITCH:

TR 612 top

TERMINA

2-channel 7 day timers

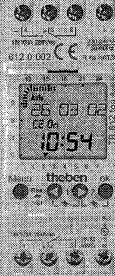

According to version preprogrammed with the current time and summer/winter norm time

Safety Information

The connection and installation of electrical appliances must be performed by a skilled electrician only. Any intervention into or modifications to the appliance shall lead to the lapse of all warranty rights. Comply with your national regulations and all relevant safety stipulations.

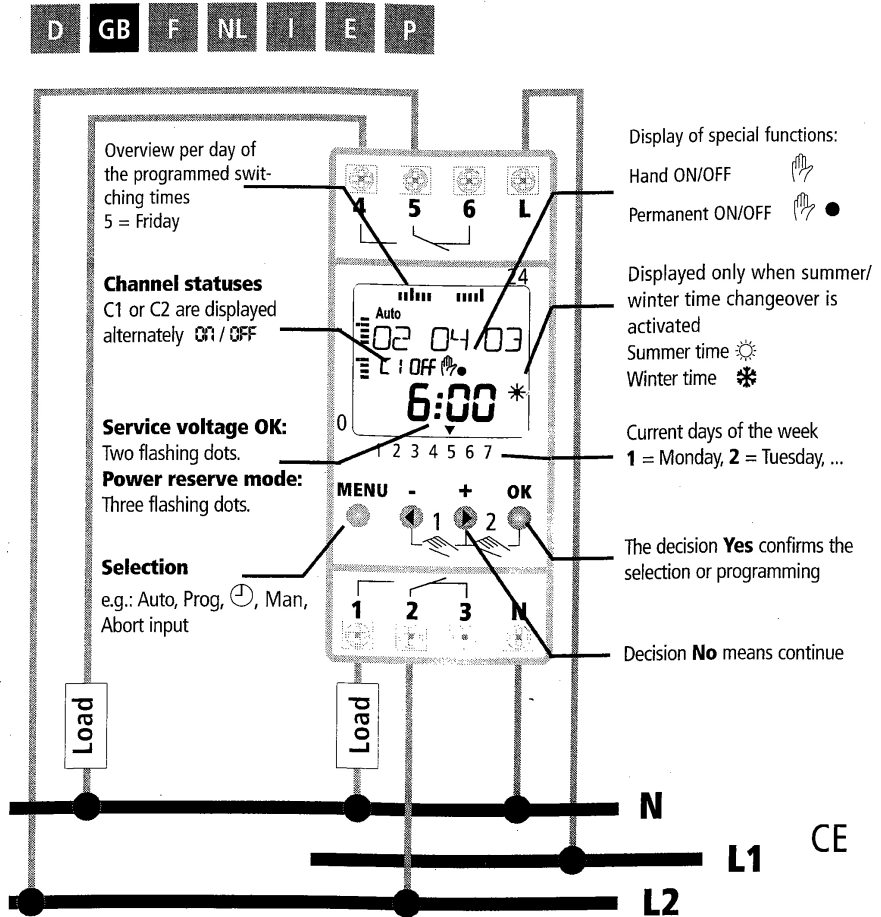

PREPARATION

First contact

Info

The timer is delivered in so-called sleep mode. To increase the power reserve the switch clock changes to the sleep mode after approx. 15 minutes.

To activate without a service voltage

Briefly press the **MENU** key.

Activate with mains voltage

If the timeswitch is already pre-programmed with the actual time, the weekday, and the changeover setting for Summer / Winter time, the actual time and status display appears after selection of the national language.

If the timer is not pre-programmed

First select your national language and then enter the actual date and time.

Activate the clock, select the national language

By pressing the \oplus or \ominus key select your national language.

Store your selection by pressing the **OK** key.

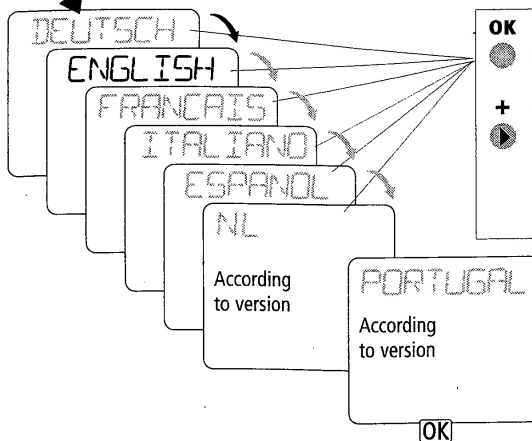
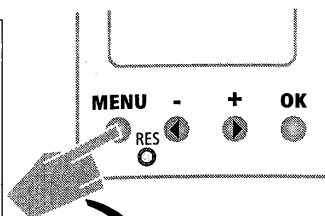

- OK** The decision **Yes**, confirms the selection or programming.
 - +** The decision **No**, means continue.
- Set or amend by pressing the \oplus or \ominus keys.

RESET (only in case of emergency): If you perform a RESET of the timer, the individual settings will be deleted. The programmes switching times remain intact. Press the **RES** key with and a pointed object for approx. 1 second.

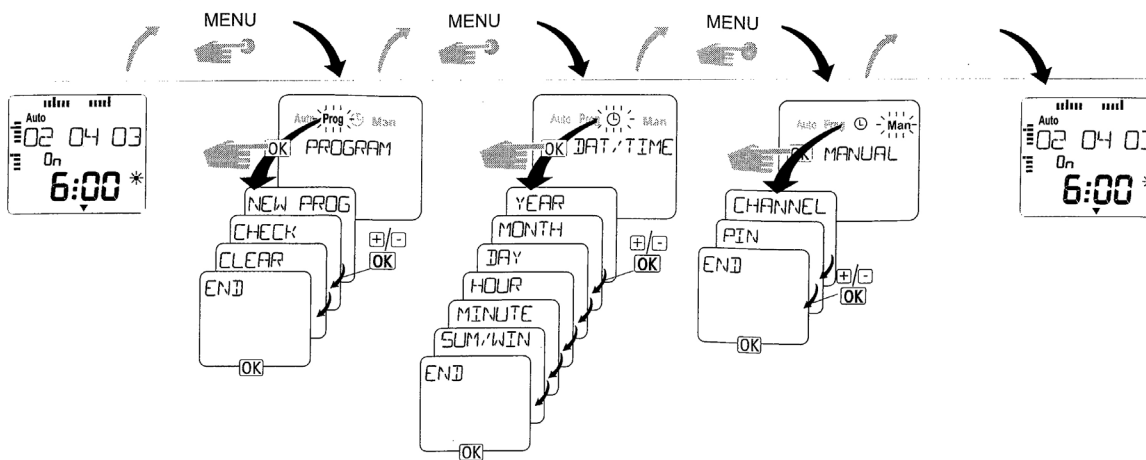

Technical data

TR 612 0 xxx 230V~ +/- 10% 50-60 Hz 240V~ +6%-14% 50-60 Hz	2x16(10)A 250 V~ min. 100 mA 24V AC/DC	Degree of protection II EN 60730 IP 20 EN 60529	2300W	9 x 7 W 7 x 11 W 7 x 15 W 7 x 20 W 7 x 23 W	400W (42µF)
TR 612 1 xxx 120V~ +/- 10% 50-60 Hz	Type 1 BSTU IEC/EN 60730-2-7	42 memory locations	AgSnO ₂	2300W	1000 W

PREPARATION

Programming the switching time

Switching times for lighting systems, machines, ventilation systems, alarm systems etc.

Formation of day groups

If the same switching times are active on several days of the week, they occupy just **one** memory location, e.g. Monday – Friday 7.30 hrs ON.

42 memory locations are available.

Group formation

In answer to the text question **Copy**, decide by pressing the **OK** key that the day program should be copied to another day of the week.

When programming an ON and OFF switching time, e.g. Monday 9 AM, a switch-off at 9 AM always has priority.

Program review

Following programming the timer makes a program review back to midnight and then sets the correct switching status.

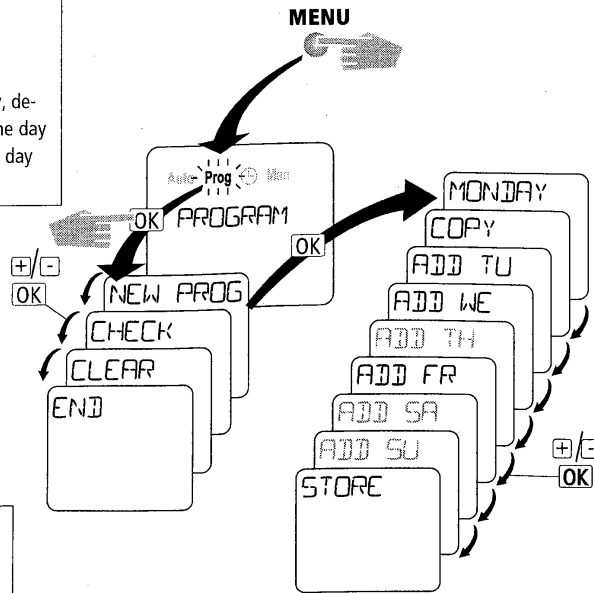

Example

Example: Switching on the lighting of a sports hall on Mon., Tues., Thurs., Fri. from 7.30h until 12h.

Programming example

Select **PROG** by pressing the **MENU** key.
Store your selection by pressing the **OK** key.
Select **NEW** by pressing the **+** or **-**.
Store your selection by pressing the **OK** key.
Select channel **C1** or **C2** by pressing **+** or **-**.
Store your selection by pressing **OK**.
Select **ON** by pressing **+** or **-**.
Store your selection by pressing **OK**.
Set the hours and minutes by pressing the **+** or **-** key.
Store selection by pressing **OK**.

To store this day of the week only

Select weekday by pressing **+** or **-**.
Select **STORE** by pressing **+**.
Store by pressing **OK**.

To copy to other days of the week

Store **COPY** by pressing **OK**.
Select weekday by pressing **+** or **-**.
Store by pressing **OK**.
To leave out a day of the week, skip by pressing the **+** key.
Finally select the **STORE** display by pressing **+**.
Store your selection by pressing **OK**.

Override Permanent ON or OFF

Individual deletions

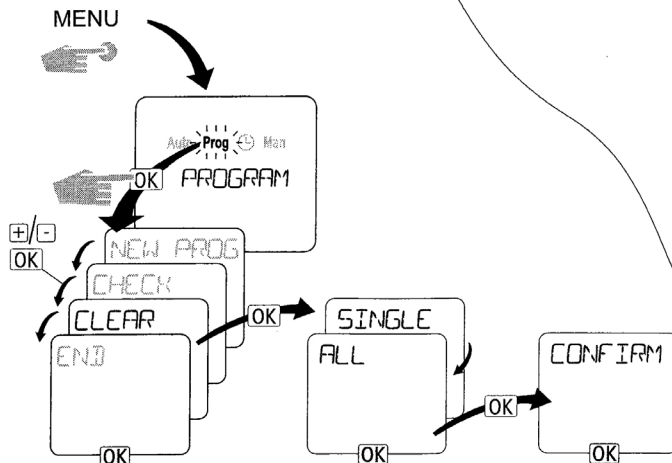

Via the automatic menu
Auto only

	Channel C1 	Channel C2
Press the two keys for approx. 1 s.	Manual preselection: Press keys simultaneously. Channel C1 switches alternately ON or OFF. Symbol appears. Manual preselection is corrected again by the stored program.	Manual preselection: Press keys simultaneously. Channel C2 switches alternately ON or OFF. Symbol appears. Manual preselection is corrected again by the stored program.
Press both keys for approx. 2 s.	Permanent ON ● OFF ●	Permanent ON ● OFF ●
Cancellation of manual preselection/ permanent switching: Briefly press the keys shown above.		

PREPARATION

Setting/ correcting the date and time summer/winter time

Automatic summer/winter time correction

According to version the timer is pre-programmed ex-works complete with the changeover. Should you switch off the automatic facility or wish to alter it, first of all read the text display. Select by pressing \oplus or \ominus .

Store by pressing OK .

Free Prog to select sum/win change-over other than EUR-GB-USA.

Select sum/win, and after with sum/win. Store with OK .

Select rule FREE – with buttons \oplus or \ominus .

Input month and weeks for sum/win. Store with OK .

E.g. Month = March

Week 4 = fourth week

Week 5 = last week in month

Note: In sum/win free Prog the time change is set automatically at sunday 2 AM.
Time change is not available.

Read the text display first of all.

Select by pressing the \oplus key or \ominus key.
Store by pressing the OK key.

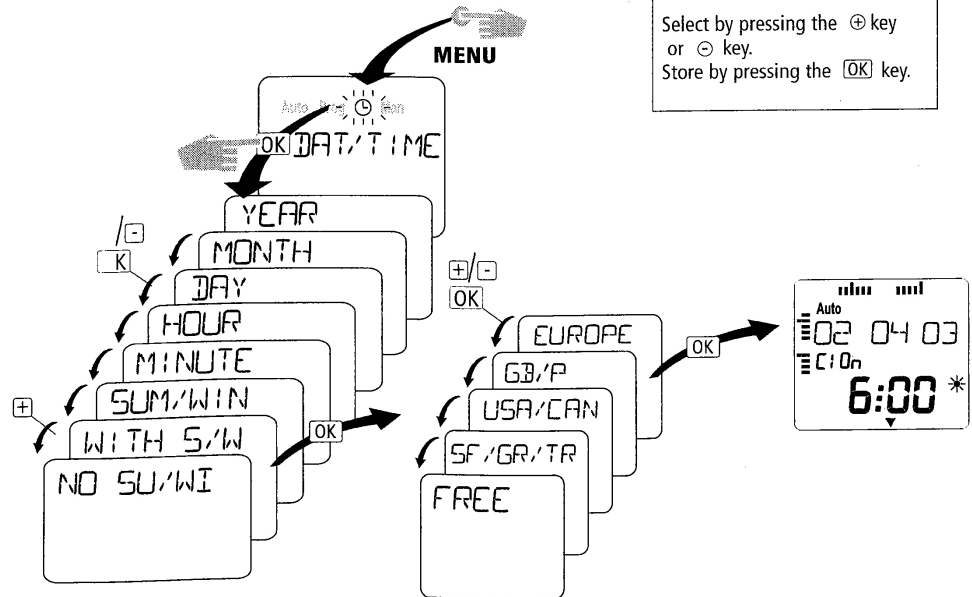

PIN code

PIN

The device can be locked against unauthorized use with a 4 digit code number.

Select the **Manual** menu using \oplus oder \ominus .
Confirm with the OK button.

Selection WITH PIN

Select **WITH PIN** using \oplus oder \ominus .

Confirm with the OK button. Make note of any desired 4-digits number.

Select the first digit of your 4 digit code using \oplus or \ominus .

Confirm the entered digit with OK .

Select further digits as described using \oplus oder \ominus .
Confirm each selected digit with the OK button.

The device is locked 90 sec. after the last keystroke and can only be operated after the correct PIN code is entered.

Selection WITHOUT PIN

Select **WITHOUT PIN** using \oplus oder \ominus .

Confirm with the OK button.

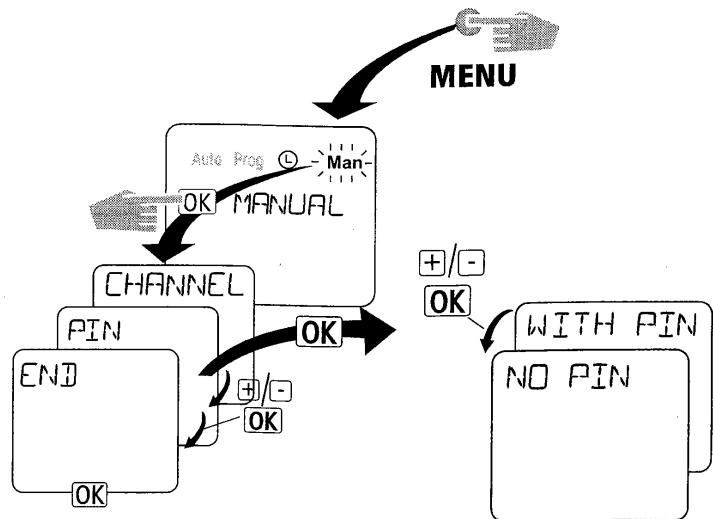

If a PIN code has been activated, the timer can no longer be activated without a valid PIN code after a RESET.

The device must be sent in!

OPERATION

1. The water recycling treatment system is now ready to operate.
2. Ensure the switches on the **Control Panel** are in the following position:

Clarifier Drain Valve
OFF

Auto-Backwash Controller
ON

Ozone / Aeration Pump
OFF

Ozone Generator
OFF

Sump Pump
ON

Filter Pump
ON

Transfer Pump
ON

pH/ORP Meters
ON

pH Pump
ON

ORP Pump
ON

3. With the sump pump running, use Water Inlet Flow Control Valve to make sure the **Inlet Flowmeter** reads at least 40GPM.
4. **Oil Skimmer** positioning must be done when water is flowing into the **Clarifier Tank** at the rated flow rate.
 - a. Tilt the **Oil Skimmer** so that it just breaks the surface of the water.
 - b. When a thick layer of oil accumulates in the **Waste Oil Decanter**, place a container below Waste Oil Release Valve and open the valve until water begins to come out.
5. Monitor the system closely the first few days to ensure smooth operation.

MAINTENANCE

WASTE OIL DECANTER:

1. The **Oil Skimmer** removes the top layer of oil and water from the **Oil Separation Chamber** and sends it to the **Waste Oil Decanter**.
2. As the **Waste Oil Decanter** fills with the oil/water mixture, the oil will float to the top while the water remains on the bottom.
3. The water then moves up the standpipe, through the **Oil Decanter Outlet**, and back to the **Wash Water Catch Pit** to be recycled again.
4. As oil accumulates, it will have to periodically be removed from the **Waste Oil Decanter**.
 - a. Place a 5 gallon bucket below the hose on the Waste Oil Release Valve
 - b. Open the Waste Oil Release Valve and allow oil to flow into the 5 gallon bucket. Turn off valve when water begins flowing into the bucket.
 - c. Dispose of oil according to EPA Standard

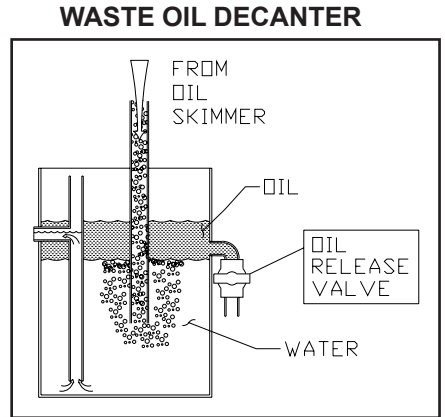

WCL-0026-030100-WKB

SOLIDS COLLECTION AREA:

The solids collection area of the **Solids Separation Chamber** will need to be cleaned occasionally to prevent overflow of solids into the **Holding Tank**.

1. Ensure the **Sludge Hose** is connected to the **Sludge Tub** and the **Sludge Outlet Assembly** and a **Filter Bag** is secured in the **Sludge Tub**.
2. The unit will automatically backwash once for each pin that is pulled out on the **Clarifier Drain Valve Timer** (See Setting the Timers to adjust).
3. The **Clarifier Drain Valve** can be opened manually by turning the **Clarifier Drain Valve Switch** to the "ON" position. The valve will remain open until the switch is turned to the "OFF" position.
4. If the solids accumulated at the bottom of the **Solids Separation Chamber** are unable to drain, open *Valve 4* and *Valve 5* to push the solids towards the **Sludge Tub**. If the solids are still unable to drain, open *Valve 6* and *Valve 7* to break up the solids on the inside of the **Solids Separation Chamber**. When the solids from the **Solids Separation Chamber** is emptied, close *Valve 4*, *Valve 5*, *Valve 6* and *Valve 7*.
5. As sludge is forced into the disposable **Filter Bag**, solids in the **Sludge** are retained by the disposable **Filter Bag** and fluids drain out into the area created by the **Riser Plate**.
6. The remaining water drains out of the bottom of the **Sludge Tub** through **Sludge Tub Outlet** and back to the **Wash Water Catch Pit**.
7. When the **Filter Bag** is filled with accumulated solids, loosen the **Hose Clamp** used to retain the **Filter Bag**, tie the **Filter Bag** off and dispose of in a manner consistent with local and federal regulations.
8. To replace the **Filter Bag**, bunch up the neck and feed it through the **Hose Clamp**, place the **Hose Clamp** and **Filter Bag** over the inside nipple on the inlet coupling and tighten the **Hose Clamp**.

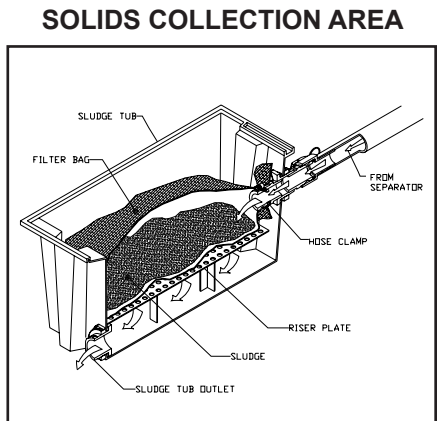

WCP-0027030700-WKB

MAINTENANCE

BACKWASHING OF FILTERS:

The unit will automatically backwash once for each pin that is pulled out on the Automatic Backwash Timer (See Setting the Timers). If an additional backwash is desired, follow the manual procedures below:

AUTOMATIC BACKWASH SEQUENCE:

1. The power to the unit must be turned on and the **Auto-Backwash Controller Switch** must be in the "ON" position.
2. **Automatic Backwash Timer** turns on at specified time.
3. **Backwashing When Lit** light turns on.
4. **Multimedia Filter Valve** moves to backwash position.
5. **Filter Pump** turns on and runs for 10 minutes.
6. **Filter Pump** turns off.
7. **Multimedia Filter Valve** moves to filter position.
8. **Polishing Filter Valve** moves to backwash position.
9. **Filter Pump** turns on and runs for 5 minutes.
10. **Filter Pump** turns off.
11. **Polishing Filter Valve** moves to filter position.

NOTE: *If filter pump is running, backwash sequence will not start until the filter pump turns off.*

MANUAL START OF BACKWASH SEQUENCE:

NOTE: *This must be done at time when pressure washers will not be in use for 15 minutes.*

1. Auto-Backwash Controller Switch MUST be in the "ON" position.
2. Press Start Backwash button.
3. Backwash will continue from #3 of the "Automatic Backwash Sequence".

MAINTENANCE

ACTIVE CARBON TEST:

To ensure the **Polishing Filter** is working effectively, you should perform an active carbon test.

- I. **TEST PROCEDURE A:** For systems with pH & ORP Control, your test kit will include test strips.
 - A. Following the directions included with the test strip kit, test the water in the **Holding Tank**.
 1. The test strip should show chlorine present in the system.
 2. If no chlorine is present, check the following:
 - a. The **ORP Adjustment Chemical** is empty. Replace.
 - b. The **ORP Pump** is turned off or malfunctioning. Ensure the **ORP Pump Switch** is in the ON position. Contact your local distributor if additional maintenance is needed.
 - c. If you are not using chlorine as an ORP control, you must refer to TEST PROCEDURE B to ensure the carbon is still active.
 - B. With the **Filter Pump** operating, use a test strip to test the incoming water to the **Product Tank**.
 1. The test should not show chlorine present in the system.
 2. If chlorine is present, the carbon must be replaced. See REMOVING AND REFILLING MEDIA section.
- II. **TEST PROCEDURE B:** For systems without pH & ORP Control, your test kit will include a Carbon removal scoop, 4 oz. empty container, 2 oz. empty container, 2 oz. bottle of chlorine, Chlorine test paper with color chart. Contact your local distributor if any parts are missing.
 - A. Turn off the **Filter Pump Switch**.
 - B. Unscrew the cap and remove the *Polishing Filter Valve*.
 - C. Fill the Carbon Removal Scoop with a sample of carbon from the **Polishing Filter** tank.
 - D. Add 2 oz. of the carbon sample into the 4 oz. empty container.
 - E. Fill the 2 oz. empty container with water.
 - F. To the water, add one drop of chlorine.
 - G. Follow the directions on the bottle of test strips. Dip a chlorine test paper into the 2 oz. container. The chlorine reading should be at least 10 parts per million. If not, add another drop of chlorine.
 - H. Add the 2 oz. of chlorine/water solution to the carbon sample in the 4 oz. container.
 - I. Tightly cap the chlorine/carbon mixture and shake occasionally for 3 minutes.
 - J. Dip a new strip of chlorine test paper into the liquid part of the 4 oz. container. Do not dip the test paper into the solid carbon as this will produce incorrect results. Read the directions on the bottle of test strips.
 - K. Check the reading against the color chart.
 1. A reading of zero means the carbon is still active.
 - a. Reassemble the dispersing section of the **Polishing Filter** and replace the *Polishing Filter Valve*.
 - b. Turn the **Filter Pump Switch** on.
 2. A positive reading means the carbon is inactive and must be recharged or replaced.

MAINTENANCE

REMOVING & REFILLING MEDIA FROM THE MULTIMEDIA & POLISHING FILTER:

1. New media can be ordered from your local distributor using the part numbers listed below.

Model	Part number	Description	Quantity	Weight (lbs.)
WCP-30AB-0M10	19-0544	36" MEDIA FILTER	1	
	33-0303	GRAVEL #3		300 LBS
	33-0304	GARNET #12		200 LBS
	33-0403	GARNET #80		300 LBS
	33-0306	FILTER AG		100 LBS
	19-0543	30" MEDIA FILTER	1	
	33-0302	ACTIVATED CARBON		165 LBS

2. Be certain to wear proper attire such as goggles, gloves, coveralls, dust mask, etc. to protect eyes and skin.
3. Turn off the **Filter Pump Switch**.
4. Remove the top from the desired filter tank using the wrench provided.
5. Use a vacuum to remove the media from the filter.
6. Ensure the lateral assembly remains centered and flush on the bottom of the tank and the layers are level when pouring media into the filter tank.
7. Reassemble the dispersing section of the filter tank and replace its corresponding valve.
8. Turn on the **Filter Pump Switch**. DO NOT backwash **Multi-Media Filter** until unit has been in operation for 24 hours.
9. Dispose of used media according to EPA standards.

SLIDE VALVE:

The **Slide Valve** needs to be disassembled so the o-rings can be greased on a monthly basis. Mi-T-M recommends using a water proof grease and apply the grease liberally.

MAINTENANCE

WATER TESTING:

Water chemical makeup should be tested on a weekly basis. With the **Sump Pump** operating, use a test strip, test the incoming water to the **Holding Tank**. (Follow the directions given with your test strips.) Use the flow chart below to check and correct the following:

1. pH: Acidity and alkalinity in the water. Low pH (acidic) will cause rusty looking water.
2. Alkalinity: Dissolvable salts in the water. Too much alkaline causes cloudiness and reduces filter life.
3. Calcium Hardness: Calcium in the water. Too much calcium creates scale buildup in coils of hot water pressure washers.
4. *Free Chlorine: Chlorine which is not combined with dirt, oils, etc. Controls odor, bacteria and algae formation.
*If using chlorine as a water purifying agent.

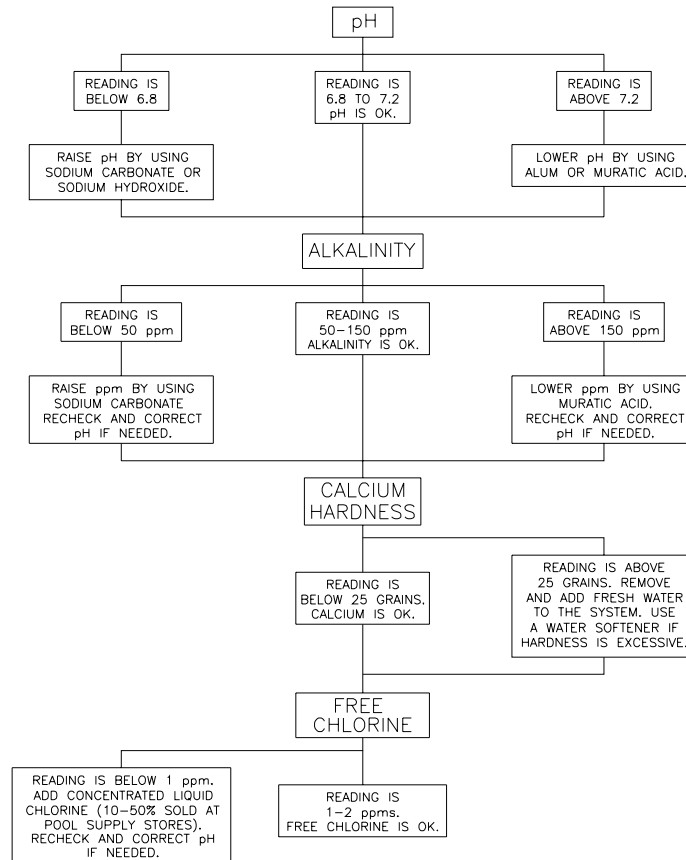

WINTERIZING:

If you must store your unit in an area where the temperature may fall below 32°F/0°C, you can protect your water recycling treatment system by draining all water from the system.

1. Follow the backwashing/cleaning procedures for the **Multi-Media Filter** and **Polishing Filter**
2. Turn all switches on the **Control Panel** to the OFF position and disconnect power to the **Control Panel**.
3. Open the check valve near the **Sump Pit** and drain the water transport line. Drain **Sump Pump**.
4. Open check valve at the inlet and drain the inlet line.
5. Remove drain plug from **Multi-Media Filter** and **Polishing Filter** and open the **Air Bleed Valve** on each filter. Break the unions on each side.
6. Remove the drain plug from the **Filter Pump**.
7. Remove the drain plug from the **Transfer Pump**.
8. Remove the drain plugs from the **Sump Pump**.
9. Follow the procedures listed for the solids collection area in the maintenance section. Completely drain the **Clarifier Tank**.
10. Remove the **pH and ORP Sensor Probes** and place them in their original containers filled with deionized water. Store at room temperature.
11. Drain the **Ozone System Plumbing** and the **Ozone Pump**.
12. Store all chemicals at room temperature.

SYMPTOM	TROUBLESHOOTING PROBABLE CAUSE	REMEDY
<p><u>SUMP PUMP</u> Sump Pump will not run.</p>	<p>Floats are not adjusted correctly in the Sump Pit.</p> <p>Not enough water in the Sump Pit.</p> <p>Float 1 is defective.</p> <p>High Sump Pump Float in the Holding Tank has flipped up.</p> <p>Circuit overload/breaker has tripped.</p> <p>Motor overload.</p>	<p>Readjust.</p> <p>Add water to the Sump Pit.</p> <p>Replace.</p> <p>Wait for water to drain from holding tank. Then push High Sump Pump Float down, or remove excess water in the Holding Tank.</p> <p>Reset breaker or replace fuse at power source..</p> <p>Allow motor to cool. Motor will automatically restart when cool.</p>
<p>Sump Pump motor starts and stops frequently.</p>	<p>Motor is defective.</p> <p>This is a common occurrence on initial start-up while pits are filling.</p> <p>Excessive water flow to reclaim unit. Sump Pump impeller is clogged.</p> <p>Motor overload.</p> <p>Sump Pit is not large enough.</p>	<p>Replace pump.</p> <p>Allow pits to fill.</p> <p>Turn valve clockwise to reduce flow.</p> <p>Disconnect power and unclog impeller.</p> <p>Allow motor to cool. Motor will automatically restart when cool.</p> <p>Expand size of pit.</p>
<p>Sump Pump runs, but there is little or no water discharge.</p>	<p>Strainer basket in Sump Pump is clogged.</p> <p>Water level is below pump inlet.</p> <p>There is an air lock in the Sump Pump.</p> <p>Low voltage.</p> <p>Clogged impeller or worn pump parts.</p>	<p>Clean, repair or replace</p> <p>Ensure Float 1 is not caught in plumbing.</p> <p>Manually fill the inlet pipe with water.</p> <p>Ensure wire size is capable of handling the rated amperage of the unit. If wire size is correct, contact your distributor.</p> <p>Contact your distributor.</p>
<p>Sump Pump will not turn off.</p>	<p>Defective switch inside Float 1.</p> <p>Pump is air locked.</p>	<p>Replace.</p> <p>Cycle pump in one minute increments several times to clear air from pump.</p>

TROUBLESHOOTING

SYMPTOM	PROBABLE CAUSE	REMEDY
<u>ELECTRICAL</u>		
No power at Control Panel .	Power failure to Control Panel .	Check circuit breaker at power source or contact your local distributor.
Power Indicator Light is OFF.	Blown fuses inside Control Panel. on step down transformer.	Check fuses, replace if necessary. If fuses are OK, contact your distributor.
<u>CLARIFIER TANK</u>		
Water will not flow into the Clarifier Tank .	<p>Sump Pump is not turned on.</p> <p>Circuit breaker has tripped or is "OFF".</p> <p>High Sump Pump Float in Holding Tank is malfunctioning.</p> <p>Strainer basket in Sump Pump is clogged.</p> <p>Dirt is lodged in the check valve.</p> <p>Sump Pump impeller is clogged.</p> <p>Lines or valves contain frozen water.</p>	<p>Move Sump Pump Switch to "ON".</p> <p>Reset or turn breaker "ON".</p> <p>Check On/Off with voltmeter, repair or replace.</p> <p>Clean, repair, or replace.</p> <p>Clean.</p> <p>Disconnect power and clean.</p> <p>Allow to thaw. Inject with warm water. water if necessary.</p>
<u>SHAFT SEALS</u>		
Water is leaking at pumps. Short seal life.	<p>Damaged stationary shaft seal.</p> <p>Unexpected temperature and chemical usage.</p>	<p>Seal ran dry. Ensure seal chamber is filled with liquid. Replace.</p>

TROUBLESHOOTING

SYMPTOM	PROBABLE CAUSE	REMEDY
<u>FILTER PUMP</u>		
Filter Pump will not run.	Filter Pump Switch is off.	Turn switch on.
	Circuit overload/breaker has tripped.	Reset breaker or replace fuse.
	Motor overload.	Allow motor to cool. Motor will automatically restart when cool.
	Filter Pump Switch is malfunctioning.	Replace switch.
	Low Filter Pump Float or High Filter Pump Float is malfunctioning.	Check On/Off with voltmeter, repair or replace.
Filter Pump runs but there is no water discharge OR Filter Pump cycles excessively.	Plumbing is obstructed.	Remove obstruction.
	Pump sucking air.	Eliminate leaks and tighten all connections on intake line.
	Low water in Holding Tank .	Increase flow by opening <u>Water Inlet Flow Control Valve</u> .
	Check valve is leaking or stuck in closed position.	Clean or replace as necessary.
	Filters are dirty.	Backwash filters.
	Lines or valves contain frozen water.	Allow to thaw. Inject with warm water if necessary. Ensure the Sump Pit remains above freezing.
	Pump impeller is obstructed.	Disconnect power and clean.
	Pump motor is operating below maximum RPM.	Contact your local distributor.
Filter Pump is hot or turns off.	Multi-Media Filter is dirty.	Backwash.
	Low voltage.	Ensure wire size is capable of handling the rated amperage of the unit. If wire size is correct, contact your local distributor.
	Motor overload.	Allow motor to cool. Motor will automatically restart when cool.

TROUBLESHOOTING

SYMPTOM	PROBABLE CAUSE	REMEDY
<u>TRANSFER PUMP</u>		
Transfer Pump runs but there is low water discharge.	Water is being used elsewhere.	Reduce flow to other source or contact your local distributor.
	Low Transfer Pump Float is not functioning.	Check On/Off with voltmeter. Repair or replace.
	Timer kicked in. Water is recycling	Do not run pressure washers while water is in timed recycle mode.
	Rain Water Overflow is discharging too much water.	Reduce flow by adjusting solenoid on the Rain Water Overflow .
	Plumbing is obstructed or too small.	Remove obstruction or use larger plumbing.
	Scale buildup in metal piping.	Replace with plastic plumbing.
Transfer Pump cycles excessively.	Solenoid valve(s) is open or stuck open.	Fix Solenoid valve(s) or reduce flow.
	Pump sucking air.	Eliminate leaks and tighten all connections on intake line.
	Bladder failure in Pressure Tank .	Replace Pressure Tank .
	Pressure switch malfunction.	Adjust pressure settings.
	Too low of pressure in the Pressure Tank .	Increase pressure.
Transfer Pump does not turn off.	Wait 10 minutes when no water is being discharged.	Normal Operation.
	Pressure switch line is obstructed.	Disconnect line and remove obstruction. Replace.
	Pressure switch is out of alignment.	Realign or replace.
	Pressure switch contacts are frozen.	Replace if necessary.
	Impeller is obstructed.	Contact your local distributor.

TROUBLESHOOTING

SYMPTOM	PROBABLE CAUSE	REMEDY
<u>SOLENOIDS</u>		
Solenoid valve won't turn on.	Low or no water pressure.	Turn off water, switch solenoids between valves. Turn on water. If problem is corrected, replace faulty solenoid.
	No electrical contact to solenoid.	Contact your local distributor.
<hr style="border-top: 1px dashed black;"/>		
Solenoid valve leaks when turned off.	Solenoid is obstructed.	Turn off water, remove and clean solenoid.
	Damaged solenoid.	Replace.
	Solenoid o-ring is misaligned or damaged.	Realign or replace.
	Diaphragm seat is dirty.	Clean or replace.
	Diaphragm is damaged.	Replace.
<hr/>		
<u>ODOR</u>		
Excessive odor in water system.	Not enough chemicals in the system to maintain water balance.	Increase the pH and ORP set points.
	Water remains dormant in the system too long causing bacteria buildup.	Increase timer settings to recycle water.
<hr/>		
<u>CHEMICALS</u>		
Excessive chemical usage.	pH and ORP Meters are calibrated incorrectly or faulty probes.	Recalibrate meters or change probes.
Low chemical usage (with possible odor.)	Chemical pumps are not working.	Replace chemical hose inside pump. Recalibrate pH and ORP Meters .
<hr/>		
<u>WATER FLOW</u>		
Air shoots from Water Outlet.	This is a common occurrence while pump is priming.	Air will stop shooting from the water outlet when pump is primed.
	Transfer Pump is sucking air at suction inlet.	Eliminate leaks or tighten connection.
<hr style="border-top: 1px dashed black;"/>		
Water will not turn off.	Solenoid failure.	Repair or replace.

TROUBLESHOOTING

SYMPTOM	PROBABLE CAUSE	REMEDY
<p><u>AUTO-BACKWASH SYSTEM</u> Filter Pump are not fully extended or retracted. Filter valves do not extend or retract.</p>	No air pressure.	Ensure Air System Inlet pressure is at or above 60PSI.
	Debris in Filter Valve.	Call dealer to repair.
	Lack of lubrication in Filter Valve.	Increase air pressure at Air System Inlet until valve extends. Do not exceed 100PSI. Call dealer to repair.
	Pinched air line.	Check all air lines.
	Ruptured air line.	Replace.
	Faulty air valve.	Call dealer to repair.
<p>-----</p> <p>Filter Pump cycles continuously during backwash sequence.</p>	<p>Backwash flow rate is higher than inlet flow rate.</p>	<p>Sump Pump malfunctioning. See Sump Pump section of troubleshooting.</p> <p>Increase inlet flow by opening <u>Water Inlet Flow Control Valve</u>. (See PREPARATION, START-UP)</p> <p>Decrease backwash flow by closing <u>Filter Control Valve</u>. (See PREPARATION, START-UP)</p>
<p>-----</p> <p>Both Filter Valves extend and retract at the same time.</p>	<p>Filter Valve Switches are in the "ON" position.</p>	<p>Turn Filter Valve Switches to the "OFF" position whenever the Auto-Backwash Controller Switch is in the "ON" position.</p>

TROUBLESHOOTING

SYMPTOM	PROBABLE CAUSE	REMEDY
<p><u>Clarifier Drain</u> No water exits Clarifier Drain during automatic cycle.</p>	<p>Manual Solids Drain Valve is closed.</p> <p>Drain is clogged.</p>	<p>Manual Solids Drain Valve must be open from automatic cycle to work.</p> <p>See MAINTENANCE, SOLIDS COLLECTION AREA.</p>
<p>Automatic Solids Drain Valve does not fully actuate.</p>	<p>No air pressure.</p> <p>Sludge is too thick.</p> <p>Pinched air line.</p> <p>Ruptured air line.</p>	<p>Ensure Air System Inlet pressure is at or above 60PSI.</p> <p>Increase air pressure at Air System Inlet until valve actuates. Do not exceed 100PSI. Increase frequency of cycles by pulling more pins out on Clarifier Drain Valve Timer.</p> <p>Check all air lines</p> <p>Replace.</p>
<p><u>pH / ORP Meters</u> pH Pump is not running when HIGH light on pH Meter is lit. ORP Pump is not running when LOW light on ORP Meter is lit.</p>	<p>Flow Switch is not working.</p> <p>pH or ORP Pump Switch is in the "OFF" position.</p> <p>↻ and Enter buttons on Meter were pressed at the same time.</p>	<p>Inlet flow must be at least 20GPM.</p> <p>Flow Switch is clogged.</p> <p>Flow Switch is malfunctioning. Call dealer to repair.</p> <p>Turn to "ON" position.</p> <p>Turn pH / ORP Meters Switch to "OFF" position for 5 seconds then turn back to "ON" position.</p>

REPLACEMENT PARTS

DESCRIPTION	REORDER PART #
pH Sensor Probe	32-0538
ORP Sensor Probe	32-0540
Activated carbon / 55 lbs.	33-0302
Gravel / 100 lbs.	33-0303
Garnet #12 / 100 lbs.	33-0304
Garnet #80 / 100 lbs.	33-0403
Filter Ag / 25 lbs.	33-0306
Test Strips / 50	33-0314



STATEMENT OF WARRANTY

Mi-T-M warrants all parts (except those referred to below) of your new WCP Water recycling Treatment system to be free from defects in materials and workmanship during the following periods:

For One (1) Year from the date of original purchase:

Defective parts not subject to normal wear and tear will be repaired or replaced at Mi-T-M's option during the warranty period. In any event, reimbursement is limited to the purchase price paid.

EXCLUSIONS

1. The motor is covered under separate warranty by its respective manufacturer and is subject to the terms set forth therein.
2. Normal wear parts:

Seals	Filters	Gaskets
O-rings	Packings	Pistons
Valve Assembly	Brushes	Filtering Media
Sensors		
3. Parts damaged due to:
 - normal wear, misapplication, modifications/alterations, abuse,
 - operation at other than recommended speeds, pressures or temperature,
 - the use of caustic liquids,
 - chloride corrosion or chemical deterioration,
 - fluctuations in electrical or water supply,
 - operating unit in an abrasive, corrosive or freezing environment.
4. Parts damaged by failure to follow recommended:
 - installation, operating and maintenance procedures.
5. This warranty does not cover the cost of:
 - normal maintenance or adjustments,
 - labor charges,
 - transportation charges to Service Center,
 - freight damage.
6. The use of other than genuine Mi-T-M parts will void warranty. Parts returned, prepaid to Mi-T-M's factory or to an Authorized Service Center will be inspected and replaced free of charge if found to be defective and subject to warranty. There are no warranties which extend beyond the description of the face hereof. Under no circumstances shall Mi-T-M bear any responsibility for loss of use of the unit, loss of time or rental, inconvenience, commercial loss or consequential damages.

